

Hey! friend, new to this type of gamebook? The rules how to play are explained as you play the game but you need to start somewhere, well go to page 048 and start there!

The title picture, look at this at your leisure, this also tells what the segment's name is as well as the author of it
 Save Badge, this tells you that you can book mark anytime during this game, go to page 049 for more info about bookmarking.
 Nothing Here.

The segment entry, after done with page of this box, you enter the segment that corresponds with the letter in quotes listed.
 Nothing Here.

The segment plan, read the red box, then blue, then green, in that order, this will give instruction on how to start the segment.
 Nothing Here.

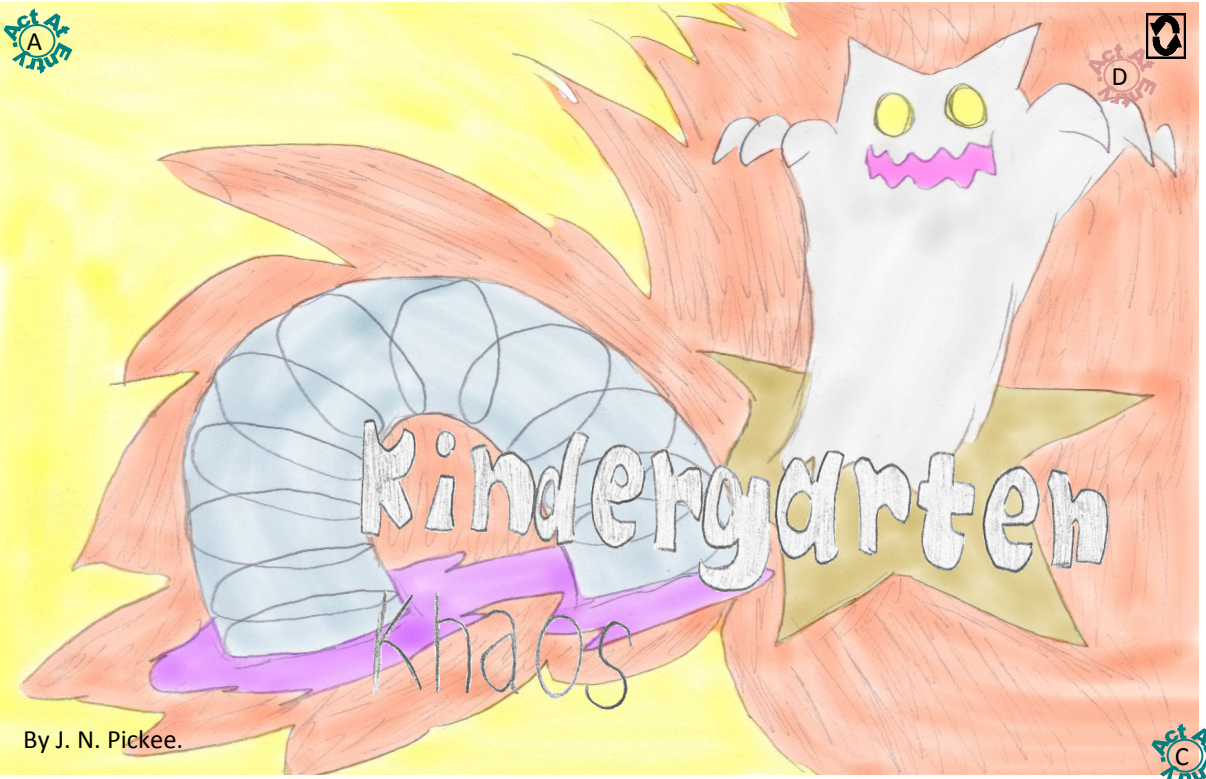

Welcome! In this segment, you are "Sammy Slinkee" and you will be combating "Persey Devil".

When you are ready to play, you have a choice, go to page 3 to read the beginning story, or go to page 27 to skip the beginning story (if you skip the beginning story, start on that page).

Remember to have a happy Trick Or Trashing!

The scene page, at entry, follow the arrows in reverse to the first section, and read it, to do that, read all text bubbles/boxes in it.
 The page title, it means this page is a scene page, in order for this page to be a match the letter in this must also match segment.
 Nothing Here.

A segue arrow, when you read a section of the scene page, follow this into the next section and read it like the last.
 A start page box, when you read all sections of this page, go to page of number listed in this, and start on that page.

A tune box, read/pronounce the red words in this box then hum the rhythm of that pronunciation in your mind reading section.
 Nothing Here.

Doe Duh Dah Deahhhhhhhhhh
 Doe Duh Dah Deeeeeeeeeeeeeee
 (keep repeating as you are reading this section)

Woops!

My garden!
 Come back here spring chicken!!!

Yipe!

Sammy and Persey enter a kindergarten, slam! The gates are shut and kindergarten starts..

Doo-Deddoh Dodo
 Deaddo Dudu Deaddo
 (keep repeating as you are reading this section)

Doe Duh Dah Deh
 (keep repeating as you are reading this section)

Hey! don't change the subject! You are still dead! Hoo ha ha ha!

Oh? A kindergarten?

Bouncing, Sammy Goes.....





Hooduh Heh Headduh Hoe Hooduh Heh
 Hoodoo Hoodoo Hoodoo Hoodoo
 Hoodoo.
 (keep repeating as you are reading this section)

The segment badge, you enter the segment that corresponds to the red letter within this if not already in a segment.
 A warp, if token moves onto this, it goes to page of number listed on this above, there, it moves on spot of ID listed on this below.
 Nothing Here.



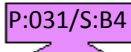
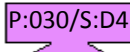

Player Box, once per. Segment, when you come to this, for each number, go to page with number same as number on this box.
 Nothing Here.

Link, if token moves into a arrow of this from beside spot, it goes to page of number listed, there, it moves on spot of ID listed.
 Nothing Here.

Ignore this

Hit   P:031/S:B4  P:030/S:D4  Do Damage    Do Damage

P:031/S:B4 P:033/S:B3 P:034/S:B2 P:028/S:D1 P:029/S:D3 P:030/S:D4

   

Listed Page: 005
Listed ID: C1

Listed Page: 006
Listed ID: D1

Listed Page: 004
Listed ID: C1

Page: 027/Spot: D3

 Opponent Token Is: Chasing - Yourself (Or) Yourself | Opponent Token Is: Evading - Yourself (Or) Yourself
 To Use Right Section: If the opponent's life is half of it's original number and you are attached to a weapon form.







 You: Page 042 /Opponent: Page 044   Ignore This. 

The segment badge, you enter the segment that corresponds to the red letter within this if not already in a segment.
 A warp, if token moves onto this, it goes to page of number listed on this above, there, it moves on spot of ID listed on this below.
 Nothing Here.



Player Box, once per. Segment, when you come to this, for each number, go to page with number same as number on this box.
 A skip stamp, when a token moves onto a spot of this stamp, that token must move 1 spot in direction this stamp is pointing to.

Link, if token moves into a arrow of this from beside spot, it goes to page of number listed, there, it moves on spot of ID listed.
 Nothing Here.

Ignore this

Hit   P:031/S:B4  P:030/S:D4  Do Damage   

P:031/S:B4 P:033/S:B3 P:034/S:B2 P:028/S:D1 P:029/S:D3 P:030/S:D4

  

Listed Page: 005
Listed ID: C1

Listed Page: 006
Listed ID: D1

Listed Page: 004
Listed ID: C1

Page: 027/Spot: D3

 Opponent Token Is: Chasing - Yourself (Or) Yourself | Opponent Token Is: Evading - Yourself (Or) Yourself
 To Use Right Section: If the opponent's life is half of it's original number and you are attached to a weapon form.

 You: Page 042 /Opponent: Page 044   Ignore This. 

The segment badge, you enter the segment that corresponds to the red letter within this if not already in a segment.
 A warp, if token moves onto this, it goes to page of number listed on this above, there, it moves on spot of ID listed on this below.
 ⚡ Nothing Here.

Player Box, once per. Segment, when you come to this, for each number, go to page with number same as number on this box.
 A skip stamp, when a token moves onto a spot of this stamp, that token must move 1 spot in direction this stamp is pointing to.

Link, if token moves into a arrow of this from beside spot, it goes to page of number listed, there, it moves on spot of ID listed.
 Nothing Here.

Ignore this

Hit ⚡057

P:007/S:D3

P:031/S:B3

⚡056 Do Damage

Listed Page: 031
Listed ID: B3

Listed Page: 004
Listed ID: B1

Listed Page: 005
Listed ID: D2

Listed Page: 004
Listed ID: C4

Listed Page: 004
Listed ID: B4

Listed Page: 004
Listed ID: A4

Listed Page: 031
Listed ID: B2

Opponent Token Is: Chasing - Yourself (Or) Yourself

Opponent Token Is: Evading - Yourself (Or) Yourself

To Use Right Section: If the opponent's life is half of it's original number and you are attached to a weapon form.

You: Page 042 /Opponent: Page 044

Play Music: 02 (To use go to page 047)

Ignore This.

The segment badge, you enter the segment that corresponds to the red letter within this if not already in a segment.
 A warp, if token moves onto this, it goes to page of number listed on this above, there, it moves on spot of ID listed on this below.
 ⚡ Nothing Here.

Player Box, once per. Segment, when you come to this, for each number, go to page with number same as number on this box.
 Nothing Here.

Link, if token moves into a arrow of this from beside spot, it goes to page of number listed, there, it moves on spot of ID listed.
 Nothing Here.

Ignore this

Hit ⚡057

⚡056 Do Damage

Listed Page: 008
Listed ID: C4

Listed Page: 008
Listed ID: C4

Listed Page: 035
Listed ID: B3

Listed Page: 035
Listed ID: C3

Listed Page: 035
Listed ID: C4

Page: 006/Spot: A1

Opponent Token Is: Chasing - Yourself (Or) Yourself

Opponent Token Is: Evading - Yourself (Or) Yourself

To Use Right Section: If the opponent's life is half of it's original number and you are attached to a weapon form.

You: Page 042 /Opponent: Page 044

Play Music: 02 (To use go to page 047)

Ignore This.

The segment badge, you enter the segment that corresponds to the red letter within this if not already in a segment.
 A warp, if token moves onto this, it goes to page of number listed on this above, there, it moves on spot of ID listed on this below.
 ⚡ Nothing Here.

Player Box, once per. Segment, when you come to this, for each number, go to page with number same as number on this box.
 A trick, if token moves onto this, move it's opposing token with it, play trick listed, token is "User" it's opponent is "Target".

Link, if token moves into a arrow of this from beside spot, it goes to page of number listed, there, it moves on spot of ID listed.
 A block, if trick box played, take the picture in middle of it and apply it as whole under all spots of this with a shared letter as it.

The segment badge, you enter the segment that corresponds to the red letter within this if not already in a segment.
 A warp, if token moves onto this, it goes to page of number listed on this above, there, it moves on spot of ID listed on this below.
 ⚡ Nothing Here.

Player Box, once per. Segment, when you come to this, for each number, go to page with number same as number on this box.
 Nothing Here.

Link, if token moves into a arrow of this from beside spot, it goes to page of number listed, there, it moves on spot of ID listed.
 Nothing Here.

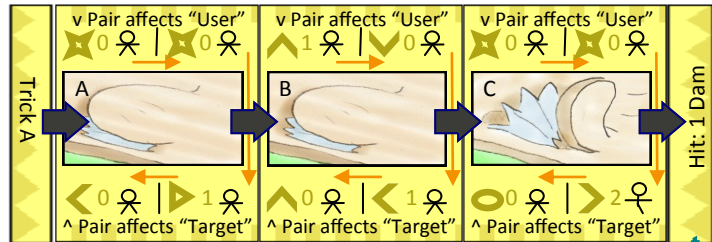

Hit 057 Page: 014/ Do Damage 058 056 Do Damage

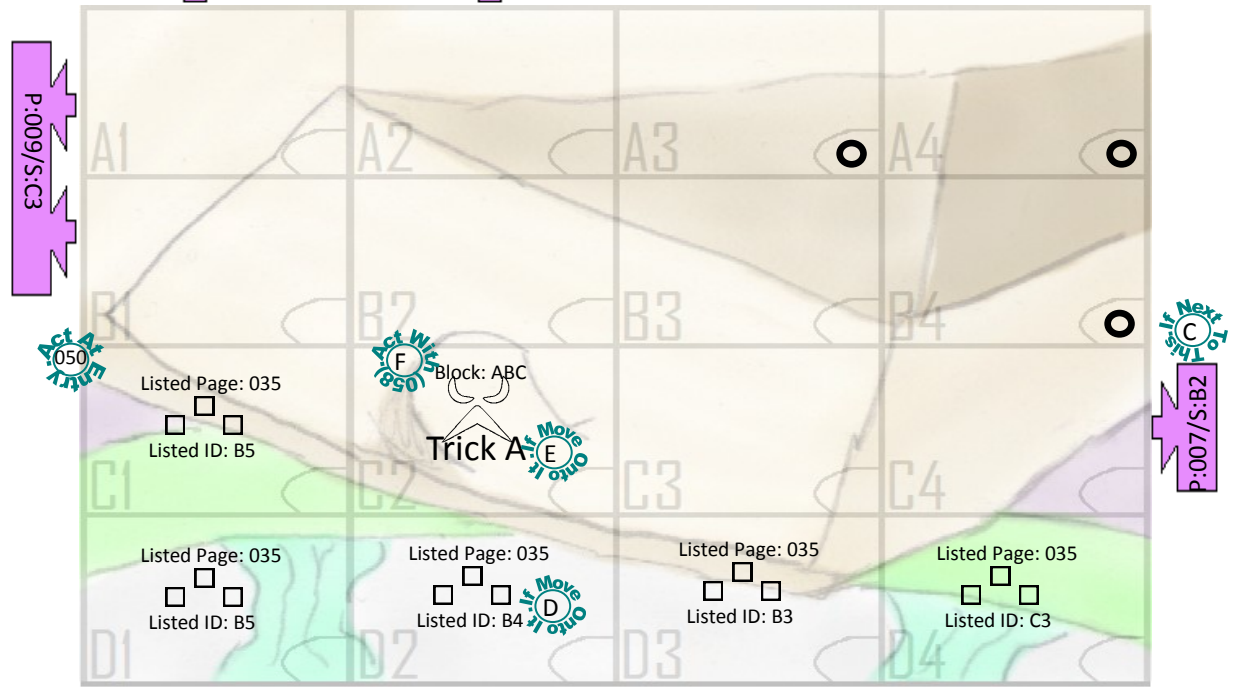

Opponent Token Is: Chasing - Trick A (Or) Yourself Opponent Token Is: Evading - Yourself (Or) Yourself
 To Use Right Section: if you are 1 spot away from the opponent token and you have a weapon form attached to you.

You: Page 042 /Opponent: Page 044 Play Music: 02 (To use go to page 047) Ignore This. 8

Ignore this

Hit 057 P:014/S:D5 Do Damage 056 Do Damage

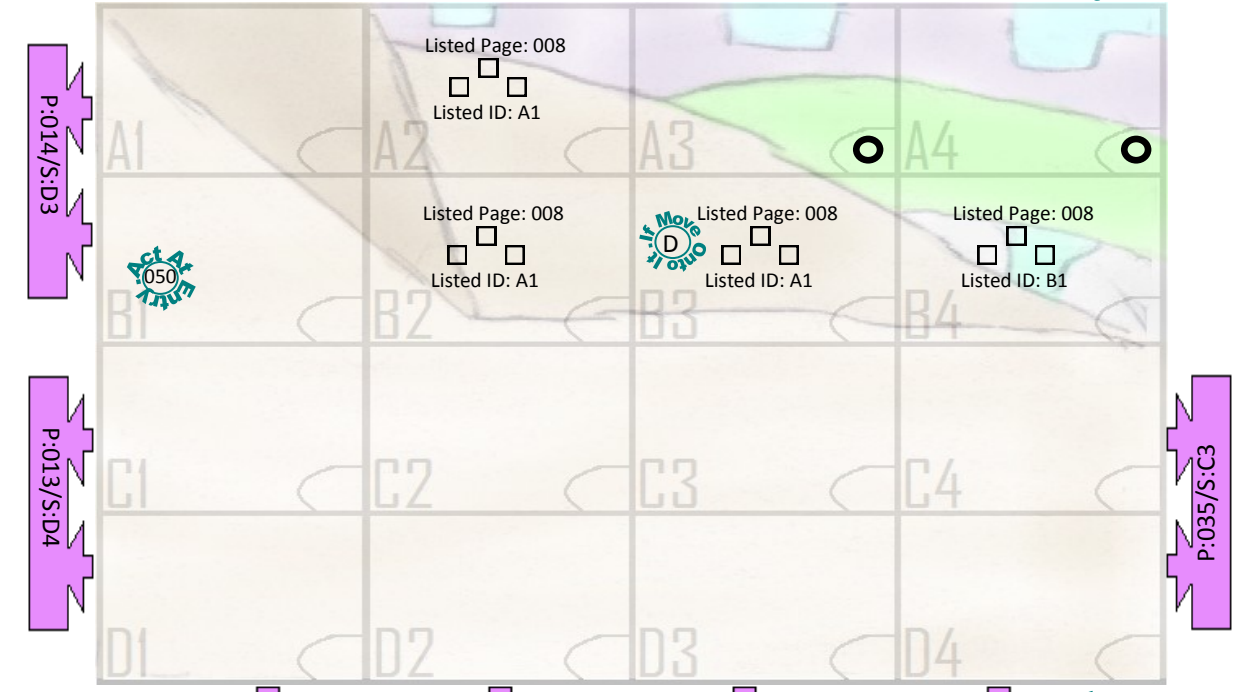

Opponent Token Is: Chasing - Yourself (Or) Yourself Opponent Token Is: Evading - Yourself (Or) Yourself
 To Use Right Section: If the opponent's life is half of it's original number and you are attached to a weapon form.

You: Page 042 /Opponent: Page 044 Play Music: 02 (To use go to page 047) Ignore This. 9

The segment badge, you enter the segment that corresponds to the red letter within this if not already in a segment.
 A warp, if token moves onto this, it goes to page of number listed on this above, there, it moves on spot of ID listed on this below.
 Nothing Here.

Player Box, once per. Segment, when you come to this, for each number, go to page with number same as number on this box.
 Nothing Here.

Link, if token moves into a arrow of this from beside spot, it goes to page of number listed, there, it moves on spot of ID listed.
 Nothing Here.

Ignore this

The segment badge, you enter the segment that corresponds to the red letter within this if not already in a segment.
 A warp, if token moves onto this, it goes to page of number listed on this above, there, it moves on spot of ID listed on this below.
 Nothing Here.

Player Box, once per. Segment, when you come to this, for each number, go to page with number same as number on this box.
 Nothing Here.

Link, if token moves into a arrow of this from beside spot, it goes to page of number listed, there, it moves on spot of ID listed.
 Nothing Here.

Ignore this

Hit 057 Do Damage

Act 050

A1	A2	A3	A4	A5	A6
Listed Page: 035 Listed ID: B5	Listed Page: 035 Listed ID: B5	Listed Page: 015 Listed ID: B5	Listed Page: 035 Listed ID: C5	Listed Page: 035 Listed ID: D5	Listed Page: 035 Listed ID: D5
B1	B2	B3	B4	B5	B6
Listed Page: 035 Listed ID: B4					
C1	C2	C3	C4	C5	C6
Listed Page: 035 Listed ID: B3					
D1	D2	D3	D4	D5	D6

P:011/S:C1

To Page: 009/On Spot: D3

Opponent Token Is: Chasing - Yourself (Or) Yourself | Opponent Token Is: Evading - Yourself (Or) Yourself
 To Use Right Section: If the opponent's life is half of it's original number and you are attached to a weapon form.

You: Page 042 /Opponent: Page 044
 Play Music: 02 (To use go to page 047)

Ignore This.

Hit 057 Do Damage

Act 050

A1	A2	A3	A4	A5	A6
Listed Page: 035 Listed ID: B5	Listed Page: 035 Listed ID: C5	Listed Page: 035 Listed ID: D5	Listed Page: 035 Listed ID: D5		
B1	B2	B3	B4	B5	B6
					Listed Page: 035 Listed ID: D4
C1	C2	C3	C4	C5	C6
					Listed Page: 035 Listed ID: D4
D1	D2	D3	D4	D5	D6

P:010/S:C6

P:012/S:D2

P:012/S:D3

To Page: 013/On Spot: D1

Opponent Token Is: Chasing - Yourself (Or) Yourself | Opponent Token Is: Evading - Yourself (Or) Yourself
 To Use Right Section: If the opponent's life is half of it's original number and you are attached to a weapon form.

You: Page 042 /Opponent: Page 044
 Play Music: 02 (To use go to page 047)

Ignore This.

The segment badge, you enter the segment that corresponds to the red letter within this if not already in a segment.
 A warp, if token moves onto this, it goes to page of number listed on this above, there, it moves on spot of ID listed on this below.
 Nothing Here.

Player Box, once per. Segment, when you come to this, for each number, go to page with number same as number on this box.
 A trick, if token moves onto this, move it's opposing token with it, play trick listed, token is "User" it's opponent is "Target".

Link, if token moves into an arrow of this from beside spot, it goes to page of number listed, there, it moves on spot of ID listed.
 A block, if trick box played, take the picture in middle of it and apply it as whole under all spots of this with a shared letter as it.

The segment badge, you enter the segment that corresponds to the red letter within this if not already in a segment.
 A warp, if token moves onto this, it goes to page of number listed on this above, there, it moves on spot of ID listed on this below.
 Nothing Here.

Player Box, once per. Segment, when you come to this, for each number, go to page with number same as number on this box.
 A weapon, if a token moves on this, equip it to the letter listed above on this, then go to the page listed under on this to continue.

Link, if token moves into an arrow of this from beside spot, it goes to page of number listed, there, it moves on spot of ID listed.
 Nothing Here.

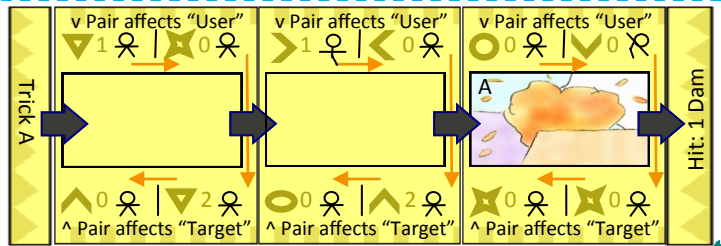

Hit 057 (Act With) 058 (Act With) 056 (Do Damage)



Hit 057 (Act With) 056 (Do Damage)

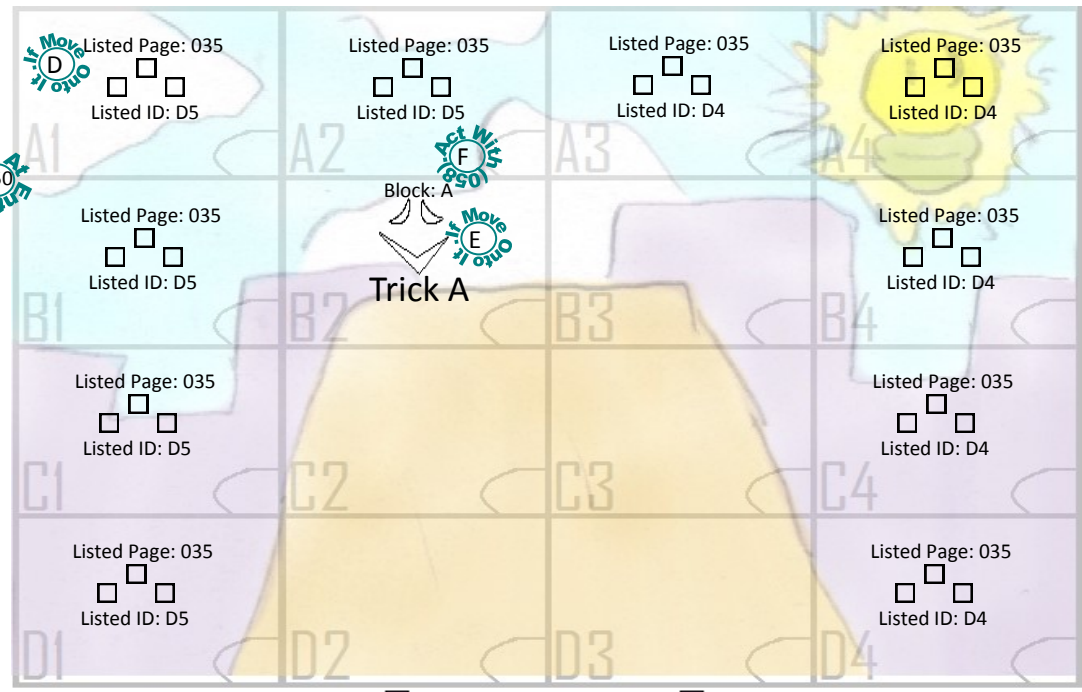

Act With 050 (Hit) Act With 050 (Hit) Act With 050 (Hit)

Opponent Token Is: Chasing - Trick A (Or) Yourself Opponent Token Is: Evading - Yourself (Or) Yourself
 To Use Right Section: if you are 1 spot away from the opponent token and you have a weapon form attached to you.

12 You: Page 042 /Opponent: Page 044 Play Music: 02 (To use go to page 047) Ignore This. 13

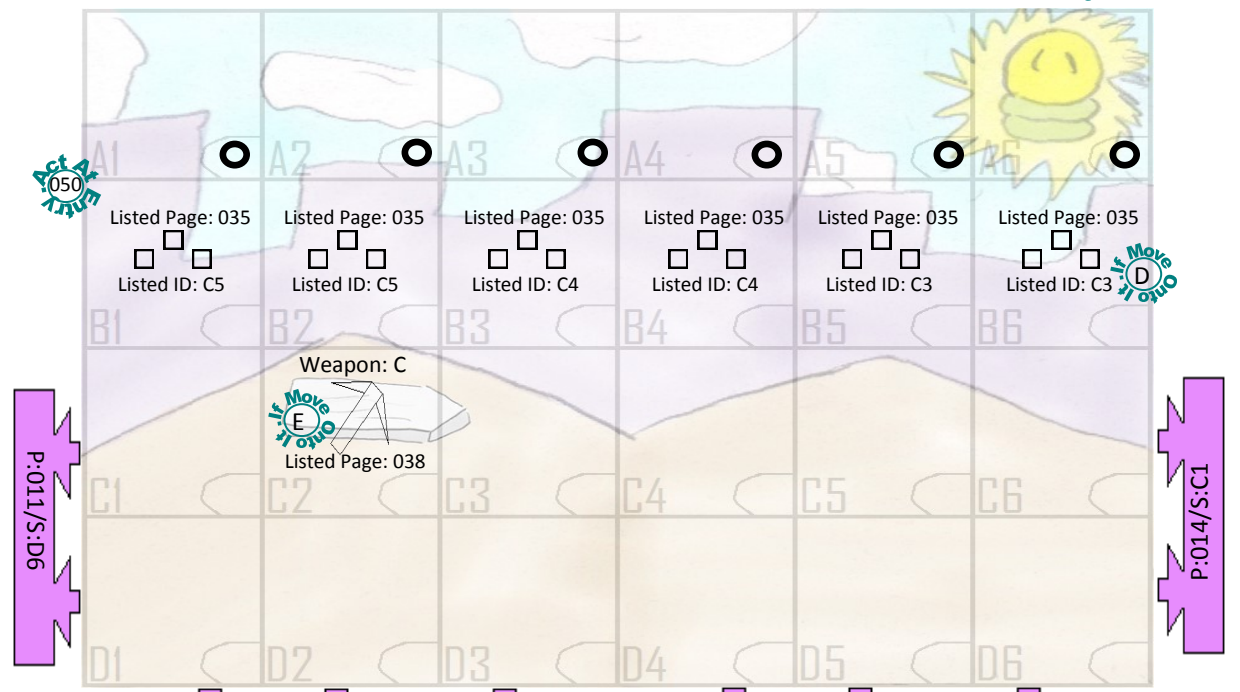

Act With 050 (Hit) Act With 050 (Hit) Act With 050 (Hit)

Opponent Token Is: Chasing - Yourself (Or) Yourself Opponent Token Is: Chasing - Weapon C (Or) Yourself
 To Use Right Section: if you are deliberately attempting to go after a feature that attaches a weapon form to yourself.

You: Page 042 /Opponent: Page 044 Play Music: 02 (To use go to page 047) Ignore This. 13

The segment badge, you enter the segment that corresponds to the red letter within this if not already in a segment.
 A warp, if token moves onto this, it goes to page of number listed on this above, there, it moves on spot of ID listed on this below.
 ⚡ Nothing Here.

Player Box, once per. Segment, when you come to this, for each number, go to page with number same as number on this box.
 A trick, if token moves onto this, move it's opposing token with it, play trick listed, token is "User" it's opponent is "Target".
 ⚡ Nothing Here.

Link, if token moves into a arrow of this from beside spot, it goes to page of number listed, there, it moves on spot of ID listed.
 Nothing Here.

The segment badge, you enter the segment that corresponds to the red letter within this if not already in a segment.
 A warp, if token moves onto this, it goes to page of number listed on this above, there, it moves on spot of ID listed on this below.
 ⚡ Nothing Here.

Player Box, once per. Segment, when you come to this, for each number, go to page with number same as number on this box.
 Nothing Here.

Link, if token moves into a arrow of this from beside spot, it goes to page of number listed, there, it moves on spot of ID listed.
 Nothing Here.

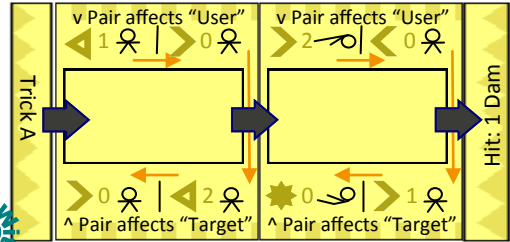

Hit 057 ⚡ Act Music 058 ⚡ Act Music 059 Do Damage 056 ⚡ Act Music 050

Hit 057 ⚡ Act Music 056 Do Damage 050

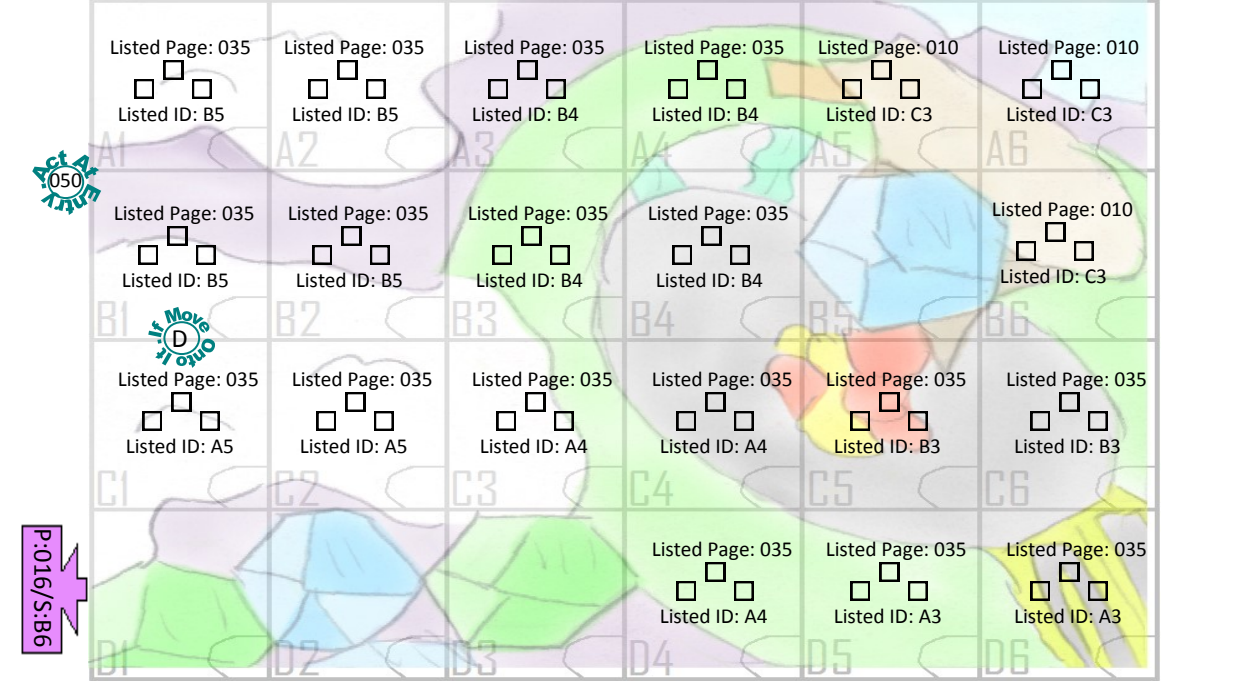
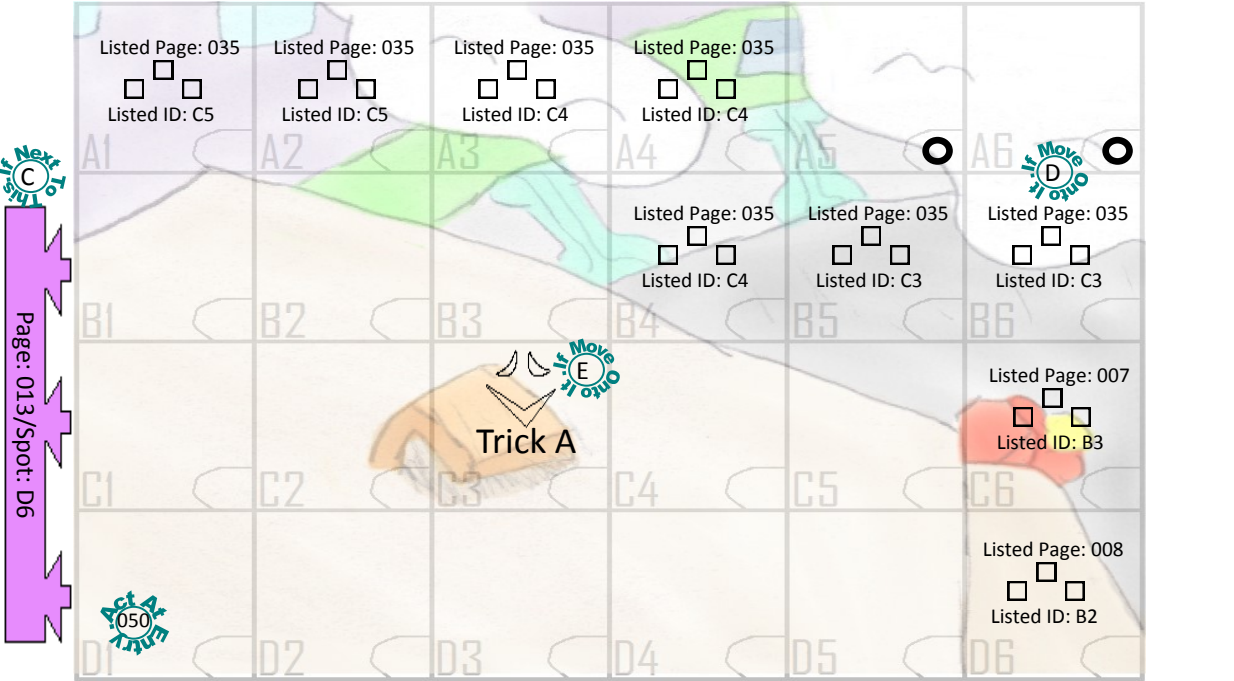

⚡ Act Music 059 To Page: 009/On Spot: C1 ⚡ Act Music 059

⚡ Act Music 059 Page: 016/Spot: B6 ⚡ Act Music 059

Opponent Token Is: Chasing - Trick A (Or) Yourself Opponent Token Is: Evading - Yourself (Or) Yourself
 To Use Right Section: if you are 1 spot away from the opponent token and you have a weapon form attached to you.

Opponent Token Is: Chasing - Yourself (Or) Yourself Opponent Token Is: Evading - Yourself (Or) Yourself
 To Use Right Section: If the opponent's life is half of it's original number and you are attached to a weapon form.

14 You: Page 042 /Opponent: Page 044 Play Music: 02 (To use go to page 047) ⚡ Act Music 050 Ignore This.

15 You: Page 042 /Opponent: Page 044 Play Music: 02 (To use go to page 047) ⚡ Act Music 050 Ignore This.

The segment badge, you enter the segment that corresponds to the red letter within this if not already in a segment.

A warp, if token moves onto this, it goes to page of number listed on this above, there, it moves on spot of ID listed on this below.

G Nothing Here.

Player Box, once per. Segment, when you come to this, for each number, go to page with number same as number on this box.

A weapon, if a token moves on this, equip it to the letter listed above on this, then go to the page listed under on this to continue.

Link, if token moves into a arrow of this from beside spot, it goes to page of number listed, there, it moves on spot of ID listed.

A Backdoor, at entry, the opponent token is considered to be at page and spot (ID) of this if it is considered somewhere else.

The segment badge, you enter the segment that corresponds to the red letter within this if not already in a segment.

A weapon, if a token moves on this, equip it to the letter listed above on this, then go to the page listed under on this to continue.

G Nothing Here.

Player Box, once per. Segment, when you come to this, for each number, go to page with number same as number on this box.

A skip stamp, when a token moves onto a spot of this stamp, that token must move 1 spot in direction this stamp is pointing to.

Link, if token moves into a arrow of this from beside spot, it moves on spot of ID listed.

Nothing Here.

Ignore this

Ignore this

Opponent Token Is: Chasing - Yourself (Or) Yourself | Opponent Token Is: Chasing - Weapon D (Or) Yourself
 To Use Right Section: if you are deliberately attempting to go after a feature that attaches a weapon form to yourself.

You: Page 042 / Opponent: Page 044 | Play Music: 02 (To use go to page 047) | Ignore This. | 16

Opponent Token Is: Chasing - Yourself (Or) Yourself | Opponent Token Is: Evading - Yourself (Or) Yourself
 To Use Right Section: If the opponent's life is half of it's original number and you are attached to a weapon form.

You: Page 042 / Opponent: Page 044 | Play Music: 02 (To use go to page 047) | Ignore This. | 17

The segment badge, you enter the segment that corresponds to the red letter within this if not already in a segment.
 A skip stamp, when a token moves onto a spot of this stamp, that token must move 1 spot in direction this stamp is pointing to.
 Nothing Here.

Player Box, once per. Segment, when you come to this, for each number, go to page with number same as number on this box.
 A trick, if token moves onto this, move it's opposing token with it, play trick listed, token is "User" it's opponent is "Target".
 Nothing Here.

Link, if token moves into a arrow of this from beside spot, it goes to page of number listed, there, it moves on spot of ID listed.
 Nothing Here.

The segment badge, you enter the segment that corresponds to the red letter within this if not already in a segment.
 A warp, if token moves onto this, it goes to page of number listed on this above, there, it moves on spot of ID listed on this below.
 Nothing Here.

Player Box, once per. Segment, when you come to this, for each number, go to page with number same as number on this box.
 A Backdoor, at entry, the opponent token is considered to be at page and spot (ID) of this if it is considered somewhere else.
 Nothing Here.

Link, if token moves into a arrow of this from beside spot, it goes to page of number listed, there, it moves on spot of ID listed.
 Nothing Here.

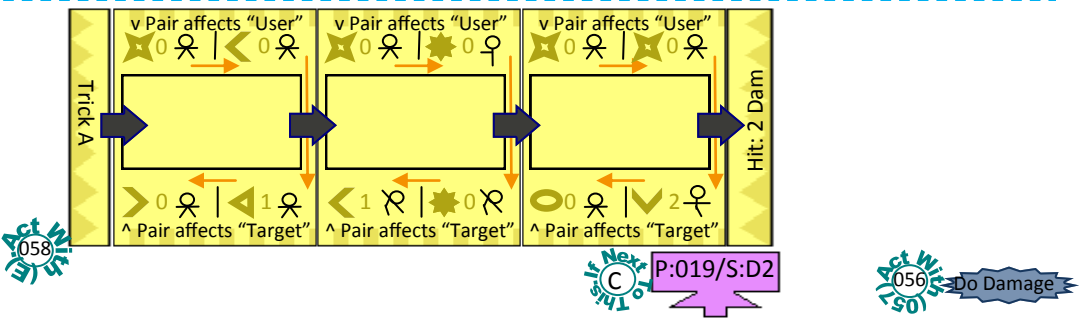

Ignore this

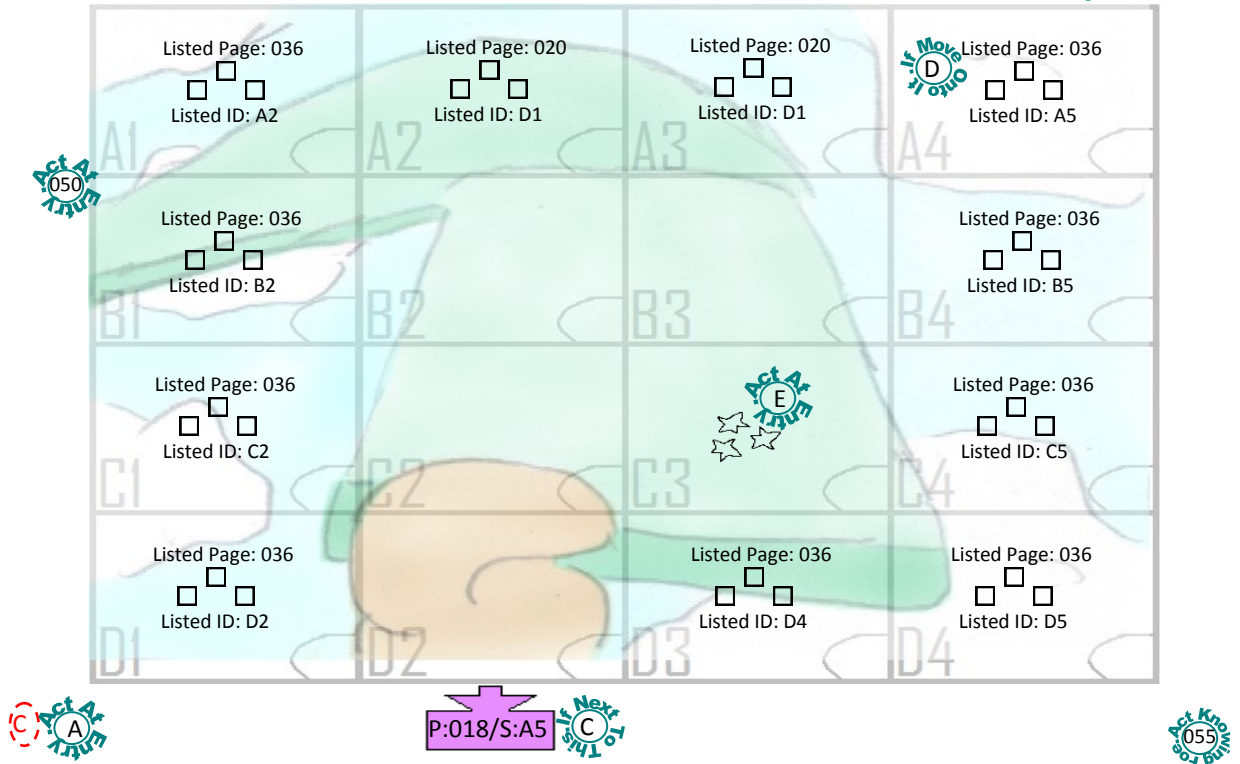
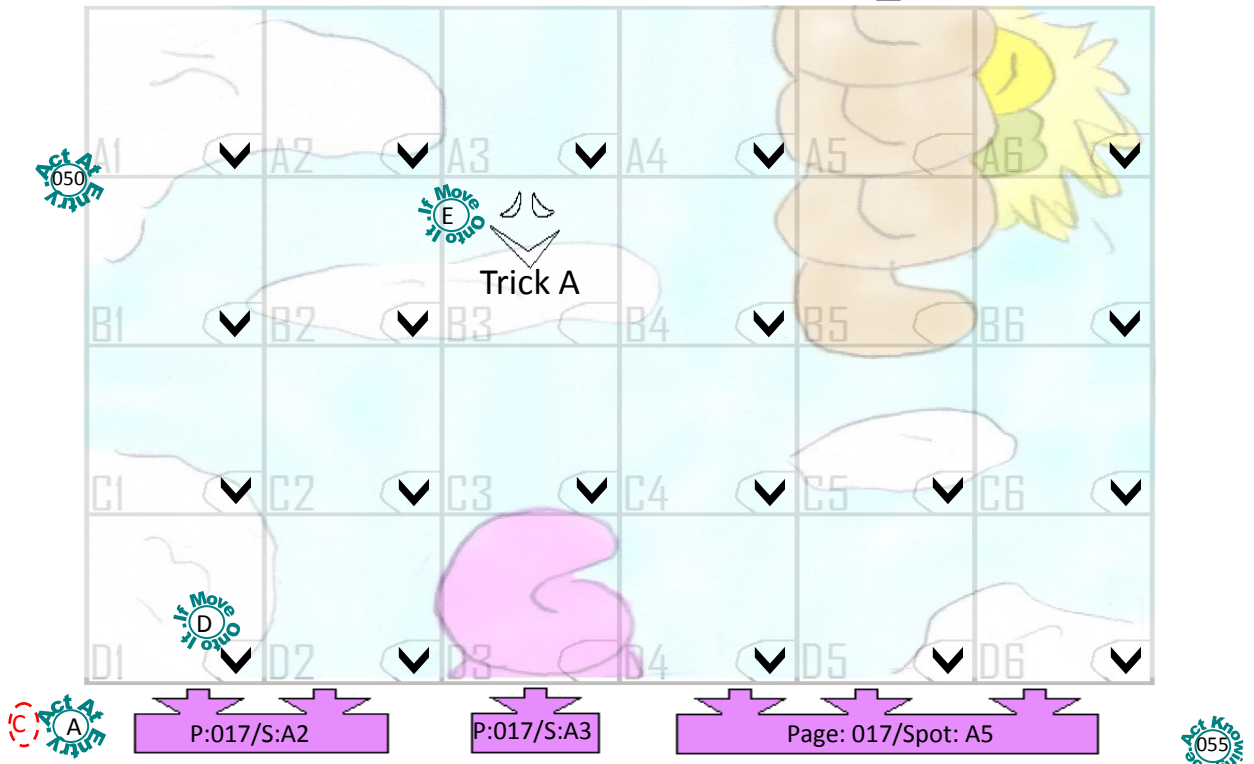

Opponent Token Is: Chasing - Yourself (Or) Yourself
 Opponent Token Is: Chasing - Link (Or) Yourself
 To Use Right Section: if you are deliberately attempting to go after Trick of this page.
 You: Page 042 /Opponent: Page 044
 Play Music: 02 (To use go to page 047)
 Ignore This.

Opponent Token Is: Chasing - Yourself (Or) Yourself
 Opponent Token Is: Evading - Yourself (Or) Yourself
 To Use Right Section: If the opponent's life is half of it's original number and you are attached to a weapon form.
 You: Page 042 /Opponent: Page 044
 Play Music: 02 (To use go to page 047)
 Ignore This.

The segment badge, you enter the segment that corresponds to the red letter within this if not already in a segment.

A warp, if token moves onto this, it goes to page of number listed on this above, there, it moves on spot of ID listed on this below.

A block, if trick box played, take the picture in middle of it and apply it as whole under all spots of this with a shared letter as it.

Player Box, once per. Segment, when you come to this, for each number, go to page with number same as number on this box.

A skip stamp, when a token moves onto a spot of this stamp, that token must move 1 spot in direction this stamp is pointing to.

Link, if token moves into a arrow of this from beside spot, it goes to page of number listed, there, it moves on spot of ID listed.

A trick, if token moves onto this, move it's opposing token with it, play trick listed, token is "User" it's opponent is "Target".

The segment badge, you enter the segment that corresponds to the red letter within this if not already in a segment.

A warp, if token moves onto this, it goes to page of number listed on this above, there, it moves on spot of ID listed on this below.

Nothing Here.

Player Box, once per. Segment, when you come to this, for each number, go to page with number same as number on this box.

A skip stamp, when a token moves onto a spot of this stamp, that token must move 1 spot in direction this stamp is pointing to.

Link, if token moves into a arrow of this from beside spot, it goes to page of number listed, there, it moves on spot of ID listed.

Nothing Here.

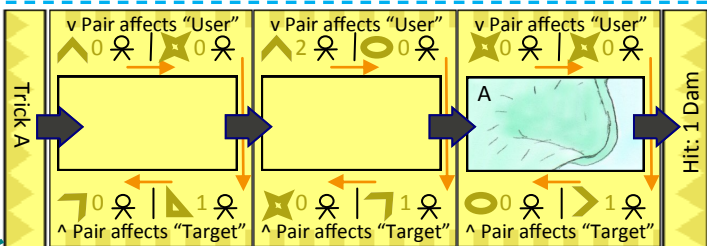

Hit 057

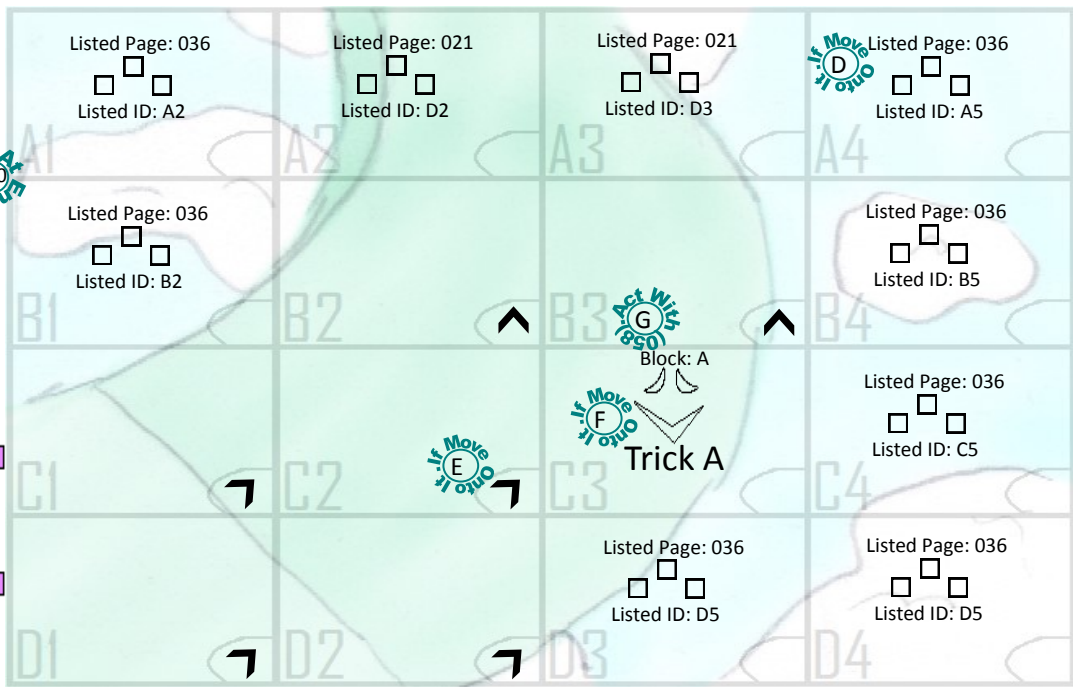

Page: 019/Spot: B3

Opponent Token Is: Chasing - Trick A (Or) Yourself | Opponent Token Is: Evading - Yourself (Or) Yourself
To Use Right Section: if you are 1 spot away from the opponent token and you have a weapon form attached to you.

20 You: Page 042 /Opponent: Page 044 Ignore This.



Hit 057

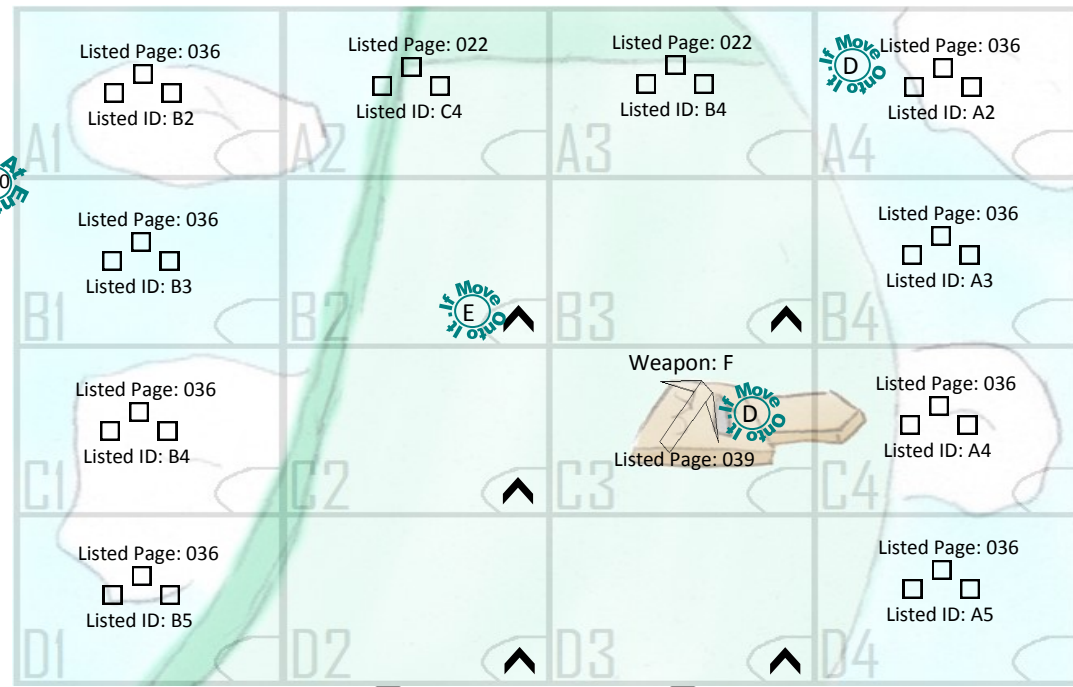

Page: 020/Spot: B2

Opponent Token Is: Chasing - Yourself (Or) Yourself | Opponent Token Is: Chasing - Weapon F (Or) Yourself
To Use Right Section: if you are deliberately attempting to go after a feature that attaches a weapon form to yourself.

21 You: Page 042 /Opponent: Page 044 Ignore This.

The segment badge, you enter the segment that corresponds to the red letter within this if not already in a segment.

A warp, if token moves onto this, it goes to page of number listed on this above, there, it moves on spot of ID listed on this below

Nothing Here.

Player Box, once per. Segment, when you come to this, for each number, go to page with number same as number on this box.

A skip stamp, when a token moves onto a spot of this stamp, that token must move 1 spot in direction this stamp is pointing to.

Link, if token moves into a arrow of this from beside spot, it goes to page of number listed, there, it moves on spot of ID listed.

Nothing Here.

The segment badge, you enter the segment that corresponds to the red letter within this if not already in a segment.

A warp, if token moves onto this, it goes to page of number listed on this above, there, it moves on spot of ID listed on this below.

Nothing Here.

Player Box, once per. Segment, when you come to this, for each number, go to page with number same as number on this box.

A Backdoor, at entry, the opponent token is considered to be at page and spot (ID) of this if it is considered somewhere else.

Link, if token moves into a arrow of this from beside spot, it goes to page of number listed, there, it moves on spot of ID listed.

Nothing Here.

Ignore this

Ignore this

Hit 057 Do Damage 056

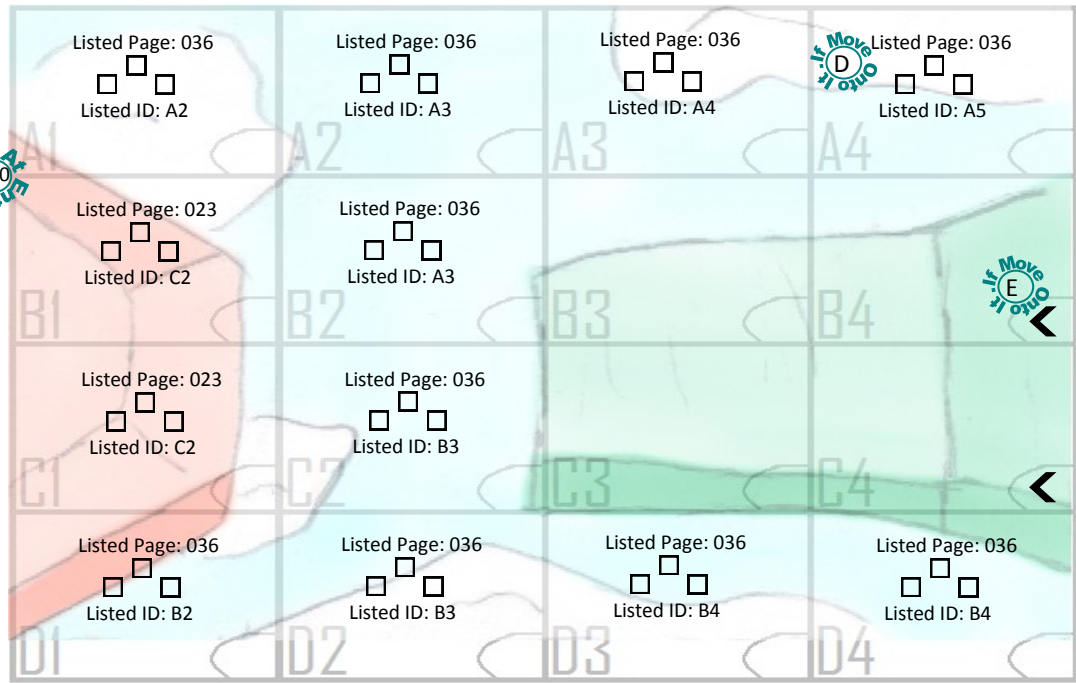

Hit 057 Do Damage 056

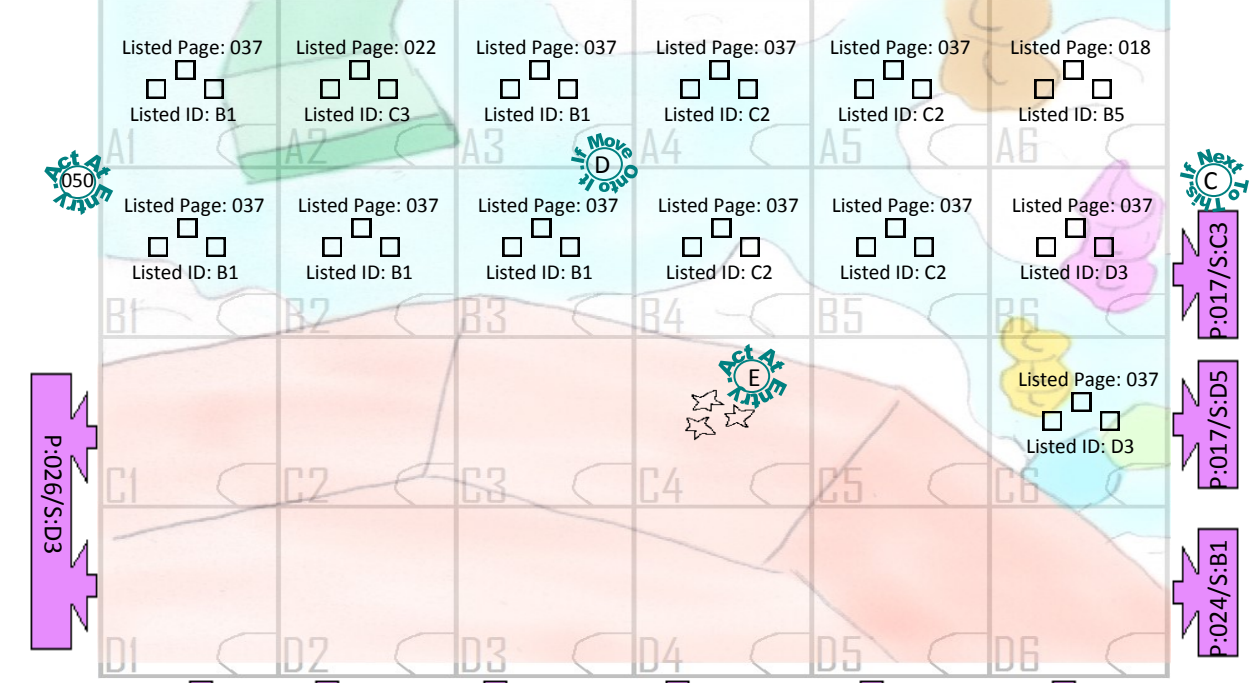

Opponent Token Is: Chasing - Yourself (Or) Yourself | Opponent Token Is: Evading - Yourself (Or) Yourself
To Use Right Section: If the opponent's life is half of it's original number and you are attached to a weapon form.

22 You: Page 042 /Opponent: Page 044 Play Music: 02 (To use go to page 047) Ignore This.

Opponent Token Is: Chasing - Yourself (Or) Yourself | Opponent Token Is: Evading - Yourself (Or) Yourself
To Use Right Section: If the opponent's life is half of it's original number and you are attached to a weapon form.

You: Page 042 /Opponent: Page 044 Play Music: 02 (To use go to page 047) Ignore This. 23

A The segment badge, you enter the segment that corresponds to the red letter within this if not already in a segment.
B A warp, if token moves onto this, it goes to page of number listed on this above, there, it moves on spot of ID listed on this below.
C Nothing Here.

D Player Box, once per. Segment, when you come to this, for each number, go to page with number same as number on this box.
E A trick, if token moves onto this, move it's opposing token with it, play trick listed, token is "User" it's opponent is "Target".
F Link, if token moves into an arrow of this from beside spot, it goes to page of number listed, there, it moves on spot of ID listed.
G A block, if trick box played, take the picture in middle of it and apply it as whole under all spots of this with a shared letter as it.

A The segment badge, you enter the segment that corresponds to the red letter within this if not already in a segment.
B A warp, if token moves onto this, it goes to page of number listed on this above, there, it moves on spot of ID listed on this below.
C Nothing Here.

D Player Box, once per. Segment, when you come to this, for each number, go to page with number same as number on this box.
E A weapon, if a token moves on this, equip it to the letter listed above on this, then go to the page listed under on this to continue.
F Link, if token moves into an arrow of this from beside spot, it goes to page of number listed, there, it moves on spot of ID listed.
G Nothing Here.

Ignore this

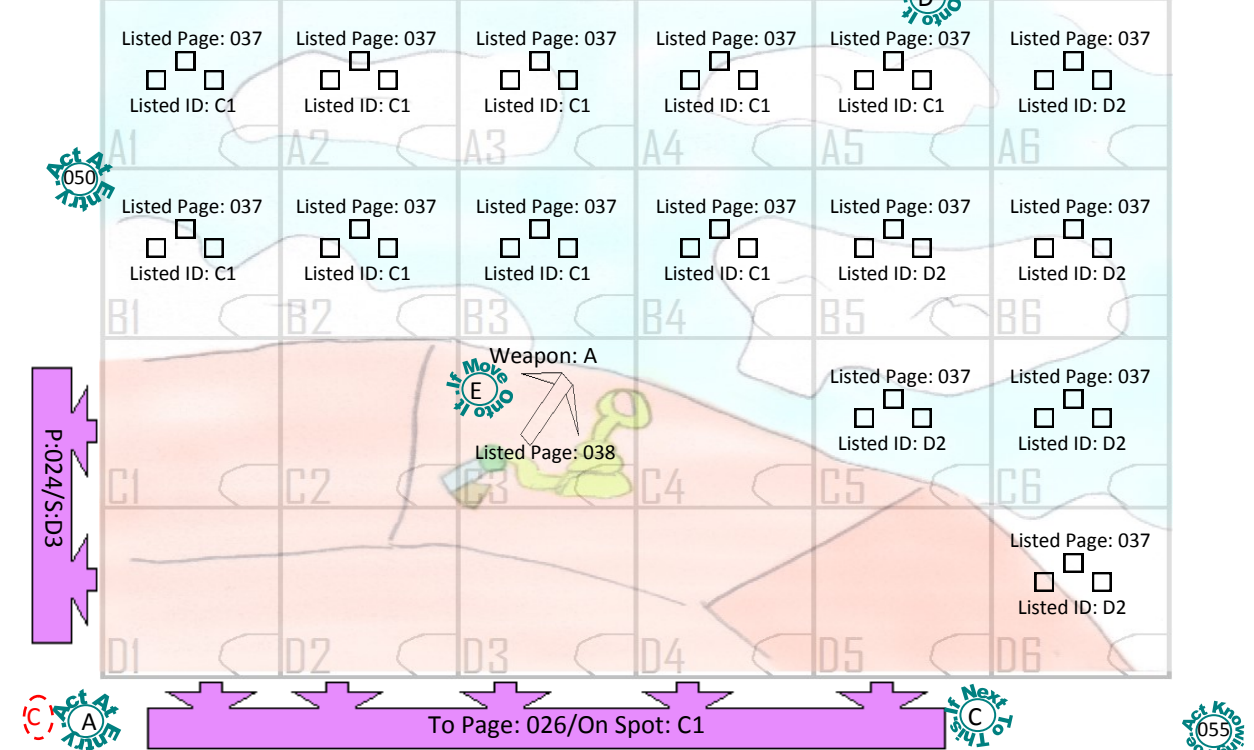
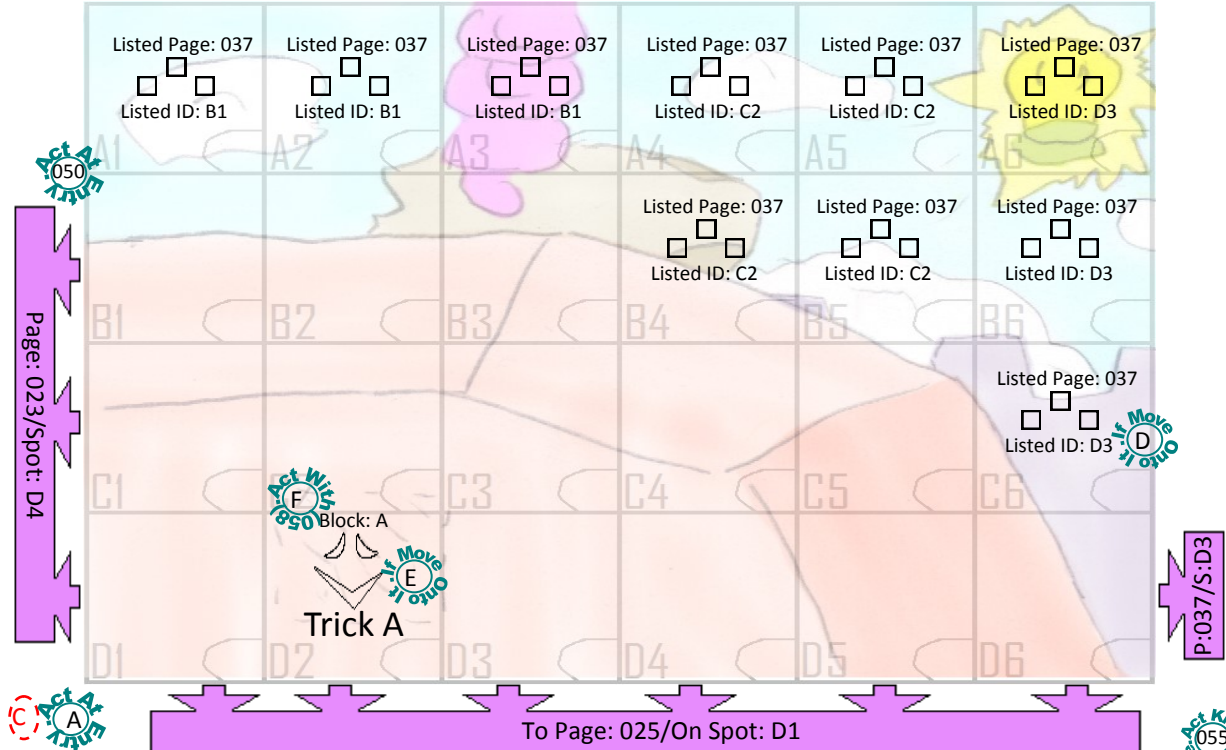
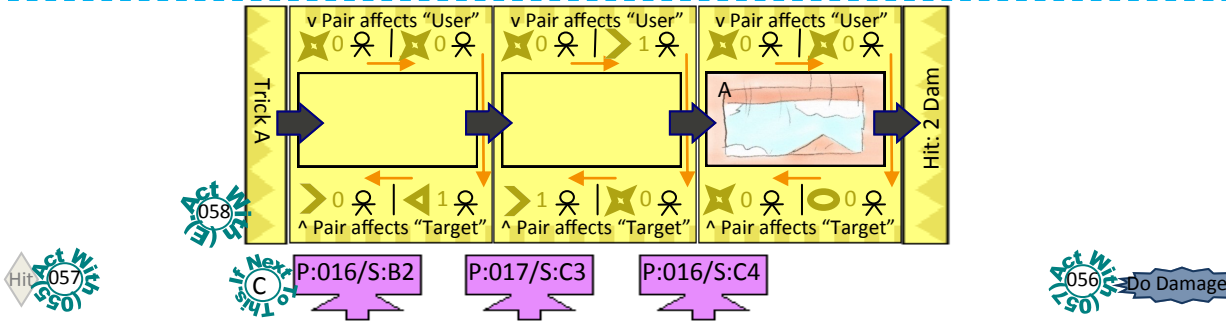

Opponent Token Is: Chasing - Trick A (Or) Yourself | Opponent Token Is: Evading - Yourself (Or) Yourself
 To Use Right Section: if you are 1 spot away from the opponent token and you have a weapon form attached to you.

Opponent Token Is: Chasing - Yourself (Or) Weapon A | Opponent Token Is: Chasing - Weapon A (Or) Yourself
 To Use Right Section: if you are attached to a weapon form and opponent is not, or if the opponent's Life is lesser then 3.

The segment badge, you enter the segment that corresponds to the red letter within this if not already in a segment.
 A warp, if token moves onto this, it goes to page of number listed on this above, there, it moves on spot of ID listed on this below.
 Nothing Here.

Player Box, once per. Segment, when you come to this, for each number, go to page with number same as number on this box.
 Nothing Here.

Link, if token moves into a arrow of this from beside spot, it goes to page of number listed, there, it moves on spot of ID listed.
 Nothing Here.

Ignore this

Opponent Token Is: Chasing - Yourself (Or) Yourself | Opponent Token Is: Evading - Yourself (Or) Yourself
 To Use Right Section: If the opponent's life is half of it's original number and you are attached to a weapon form.

The segment badge, you enter the segment that corresponds to the red letter within this if not already in a segment.
 A start, when told to start and move onto a page of this, you move onto the spot that this is in (when you learn what a "Spot" is).
 Nothing Here.

Player Box, once per. Segment, when you come to this, for each number, go to page with number same as number on this box.
 Nothing Here.

Link, if token moves into a arrow of this from beside spot, it goes to page of number listed, there, it moves on spot of ID listed.
 Nothing Here.

Ignore this

Opponent Token Is: Chasing - Yourself (Or) Yourself | Opponent Token Is: Evading - Yourself (Or) Yourself
 To Use Right Section: If the opponent's life is half of it's original number and you are attached to a weapon form.

The segment badge, you enter the segment that corresponds to the red letter within this if not already in a segment.
 A weapon, if a token moves on this, equip it to the letter listed above on this, then go to the page listed under on this to continue.
 Nothing Here.

Player Box, once per. Segment, when you come to this, for each number, go to page with number same as number on this box.
 Nothing Here.

Link, if token moves into a arrow of this from beside spot, it goes to page of number listed, there, it moves on spot of ID listed.
 Nothing Here.

The segment badge, you enter the segment that corresponds to the red letter within this if not already in a segment.
 A trick, if token moves onto this, move it's opposing token with it, play trick listed, token is "User" it's opponent is "Target".
 Nothing Here.

Player Box, once per. Segment, when you come to this, for each number, go to page with number same as number on this box.
 A block, if trick box played, take the picture in middle of it and apply it as whole under all spots of this with a shared letter as it.

Link, if token moves into a arrow of this from beside spot, it goes to page of number listed, there, it moves on spot of ID listed.
 Nothing Here.

Ignore this

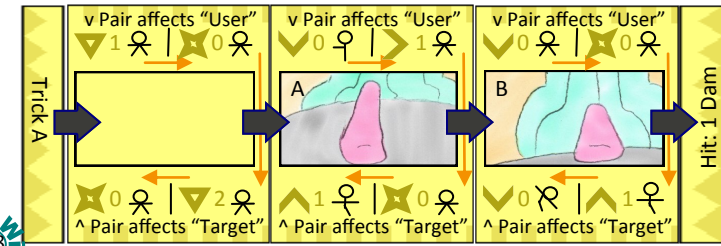

Hit 057
 050 Do Damage

Hit 057
 058
 050 Do Damage

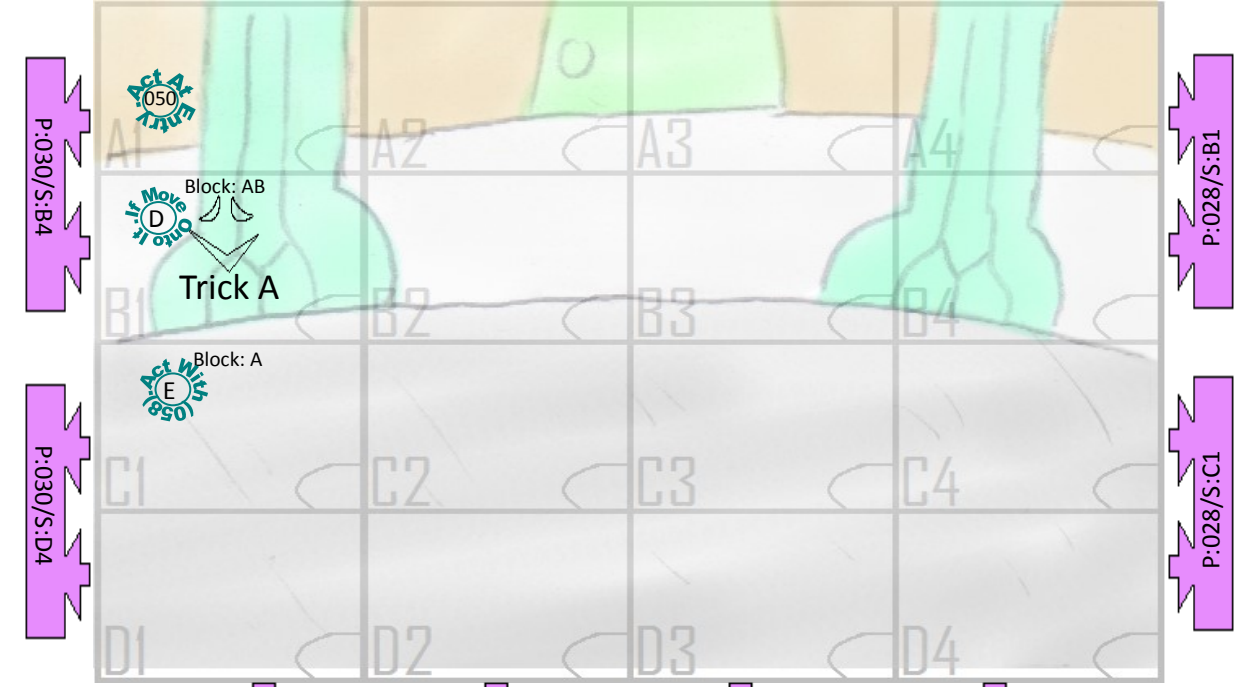
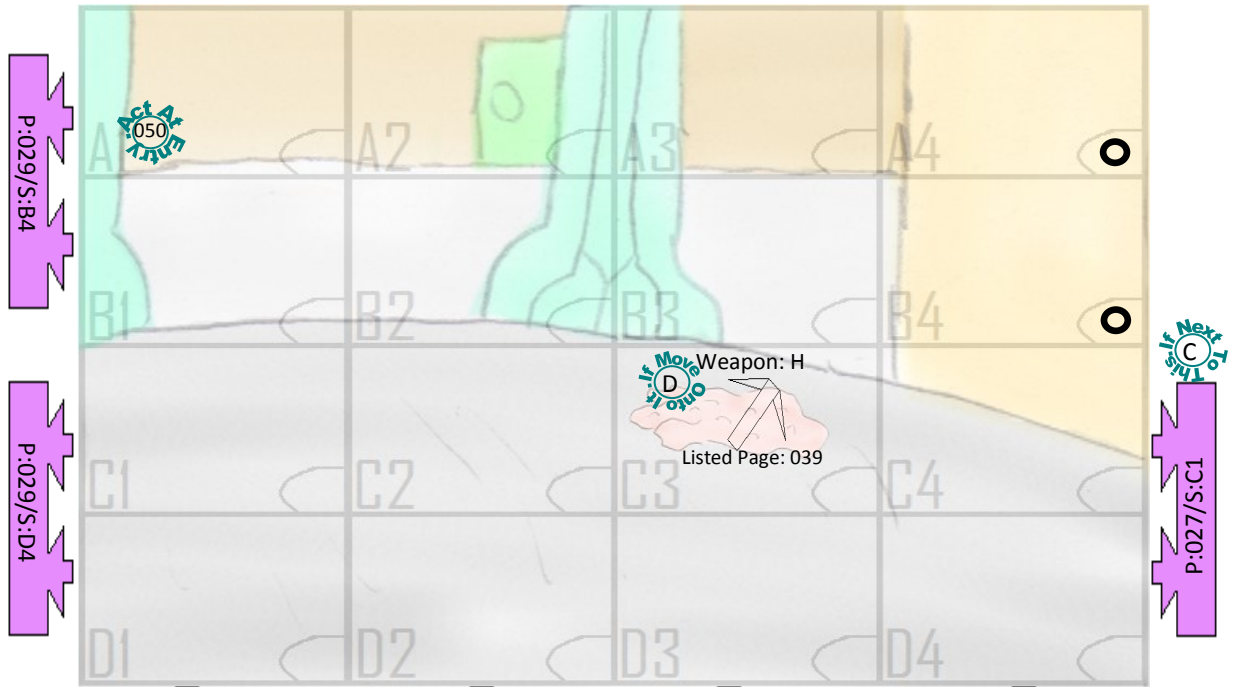

Page: 004/Spot: C4
 Page: 027/Spot: D1
 Act A 050

To Page: 004/On Spot: C4
 Act A 050

Opponent Token Is: Chasing - Yourself (Or) Yourself
 Opponent Token Is: Chasing - Weapon H (Or) Yourself
 To Use Right Section: if you are deliberately attempting to go after a feature that attaches a weapon form to yourself.

Opponent Token Is: Chasing - Trick A (Or) Yourself
 Opponent Token Is: Evading - Yourself (Or) Yourself
 To Use Right Section: if you are 1 spot away from the opponent token and you have a weapon form attached to you.

The segment badge, you enter the segment that corresponds to the red letter within this if not already in a segment.

A warp, if token moves onto this, it goes to page of number listed on this above, there, it moves on spot of ID listed on this below.

Nothing Here.

Player Box, once per. Segment, when you come to this, for each number, go to page with number same as number on this box.

A trick, if token moves onto this, move it's opposing token with it, play trick listed, token is "User" it's opponent is "Target".

Link, if token moves into an arrow of this from beside spot, it goes to page of number listed, there, it moves on spot of ID listed.

A block, if trick box played, take the picture in middle of it and apply it as whole under all spots of this with a shared letter as it.

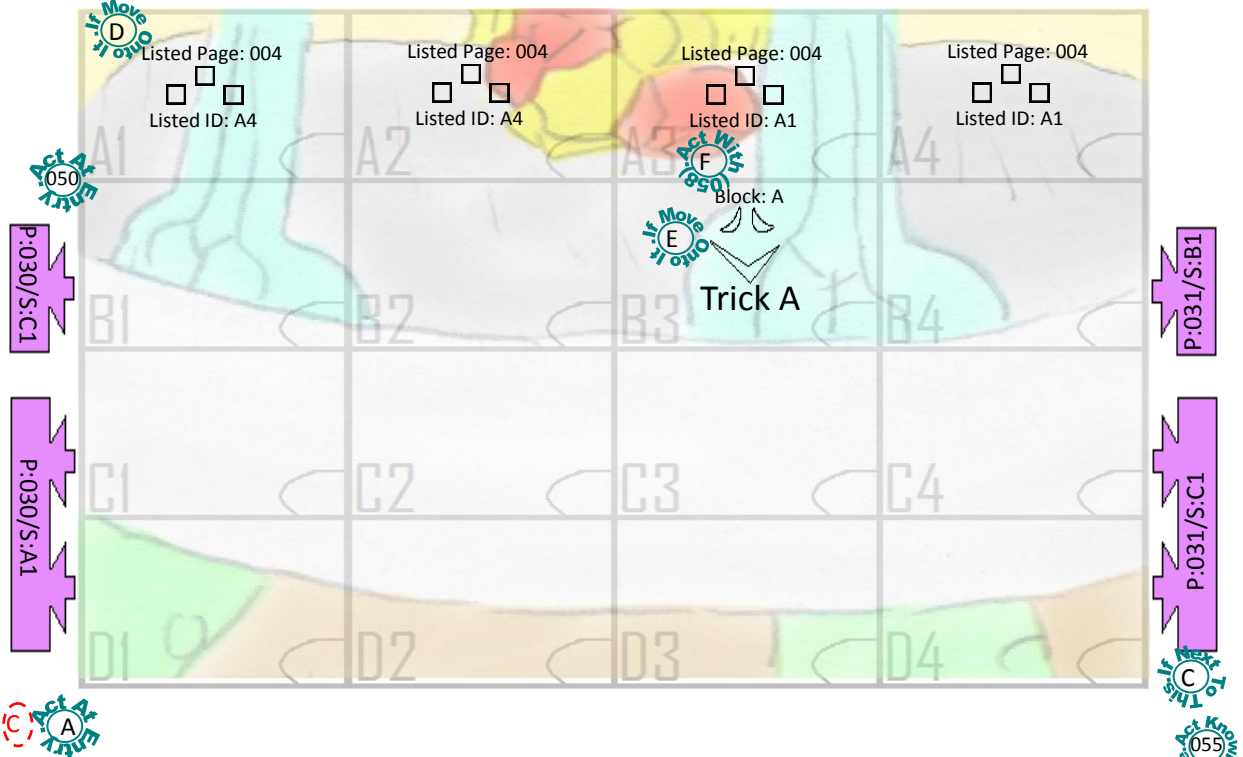
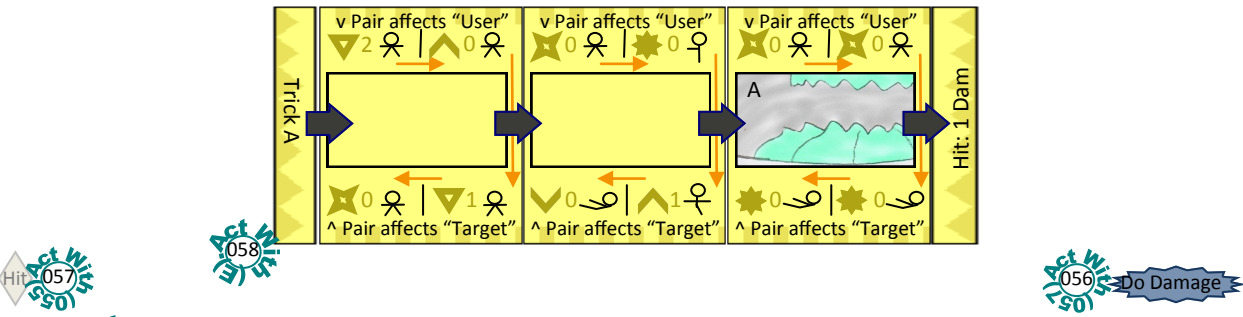

Opponent Token Is: Chasing - Trick A (Or) Yourself | Opponent Token Is: Evading - Yourself (Or) Yourself
 To Use Right Section: if you are 1 spot away from the opponent token and you have a weapon form attached to you.

The segment badge, you enter the segment that corresponds to the red letter within this if not already in a segment.

A warp, if token moves onto this, it goes to page of number listed on this above, there, it moves on spot of ID listed on this below.

Nothing Here.

Player Box, once per. Segment, when you come to this, for each number, go to page with number same as number on this box.

A trick, if token moves onto this, move it's opposing token with it, play trick listed, token is "User" it's opponent is "Target".

Link, if token moves into an arrow of this from beside spot, it goes to page of number listed, there, it moves on spot of ID listed.

A block, if trick box played, take the picture in middle of it and apply it as whole under all spots of this with a shared letter as it.

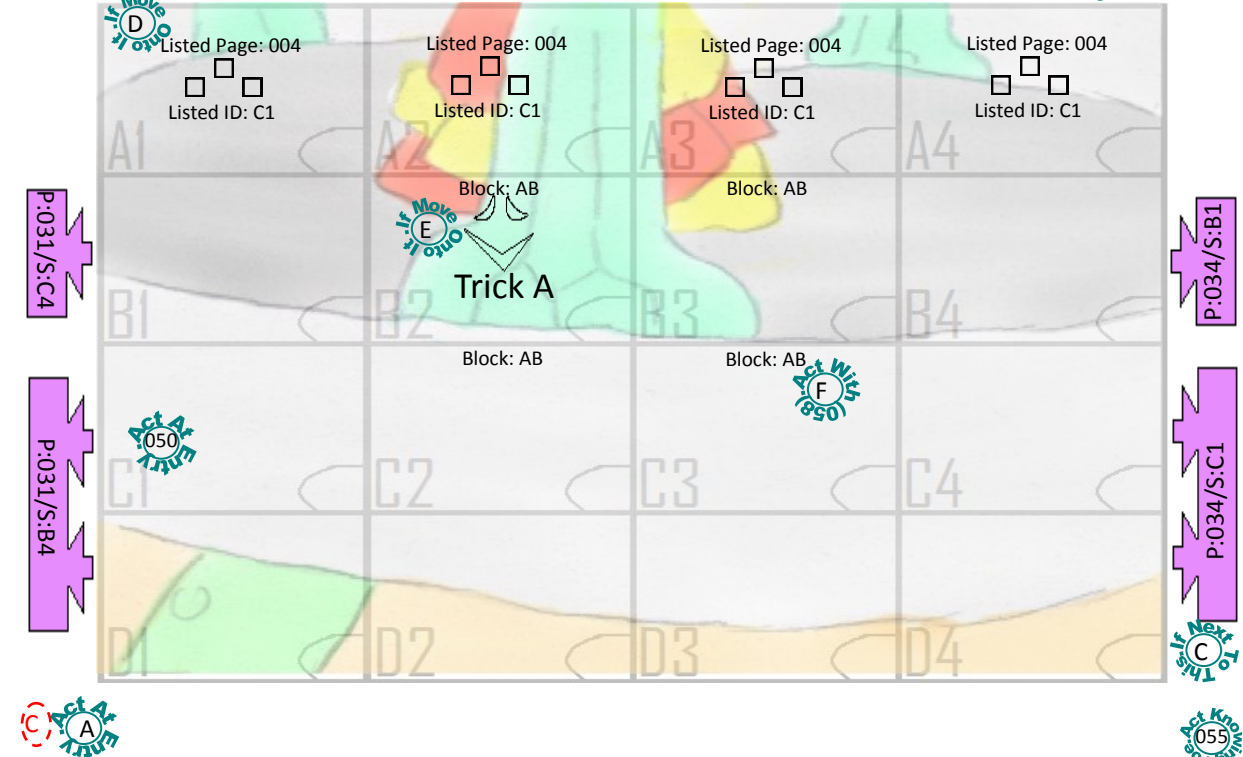
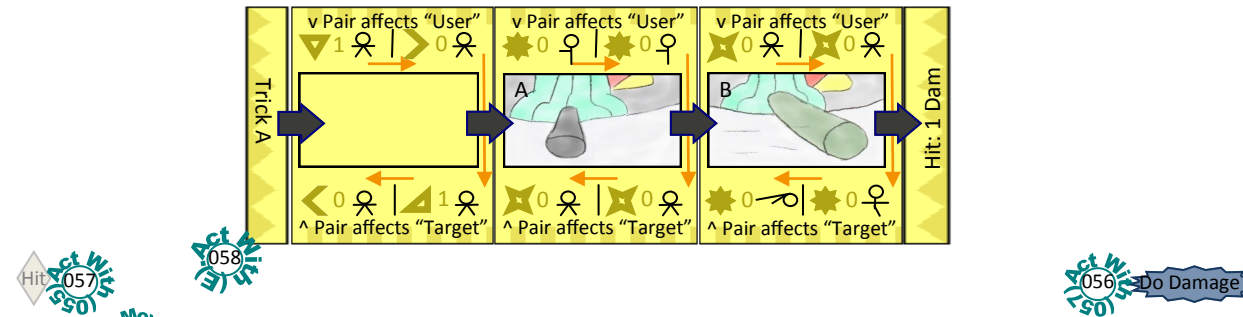

Opponent Token Is: Chasing - Trick A (Or) Yourself | Opponent Token Is: Evading - Yourself (Or) Yourself
 To Use Right Section: if you are 1 spot away from the opponent token and you have a weapon form attached to you.

The segment badge, you enter the segment that corresponds to the red letter within this if not already in a segment.

A warp, if token moves onto this, it goes to page of number listed on this above, there, it moves on spot of ID listed on this below.

Player Box, once per. Segment, when you come to this, for each number, go to page with number same as number on this box.

A trick, if token moves onto this, move it's opposing token with it, play trick listed, token is "User" it's opponent is "Target".

Link, if token moves into a arrow of this from beside spot, it goes to page of number listed, there, it moves on spot of ID listed.

A block, if trick box played, take the picture in middle of it and apply it as whole under all spots of this with a shared letter as it.

The segment badge, you enter the segment that corresponds to the red letter within this if not already in a segment.

A fall badge, each time the number of drop badge lowered on this's page, only there bring your face closer to the playfield a bit.

Player Box, once per. Segment, when you come to this, for each number, go to page with number same as number on this box.

A dive badge, all warps on the page of this page do nothing unless told to be used by a drop badge.

A drop badge, imagine the number on this lower then what it is by 1 each sec. when 0, use the warp you are on of the same page.

A warp, if token moves onto this, it goes to page of number listed on this above, there, it moves on spot of ID listed on this below.

Nothing Here.

Trick A

Hit: 2 Dam

058

Nothing Here.

Ignore this

Hit: 057

V

E

A

C

F

M

Do Damage

Listed Page: 004

Listed ID: D1

Listed Page: 004

Listed ID: D1

Listed Page: 027

Listed ID: D4

Listed Page: 027

Listed ID: D4

Block: A

Block: CD

Block: B

Trick A

050

059

Listed Page: 031

Listed ID: B3

Listed Page: 031

Listed ID: B3

Listed Page: 032

Listed ID: B2

Listed Page: 032

Listed ID: B2

Listed Page: 030

Listed ID: C3

Listed Page: 030

Listed ID: C3

Listed Page: 033

Listed ID: C1

Listed Page: 033

Listed ID: B1

Listed Page: 004

Listed ID: A1

Listed Page: 004

Listed ID: A4

Listed Page: 029

Listed ID: D1

Listed Page: 029

Listed ID: C1

Listed Page: 033

Listed ID: C4

Listed Page: 033

Listed ID: B4

Listed Page: 004

Listed ID: D1

Listed Page: 004

Listed ID: D4

Listed Page: 029

Listed ID: D4

Listed Page: 029

Listed ID: C4

Listed Page: 034

Listed ID: B2

Listed Page: 027

Listed ID: C2

Listed Page: 027

Listed ID: C2

Listed Page: 028

Listed ID: C3

Listed Page: 028

Listed ID: C3

Hit: 057

V

E

A

C

F

M

Do Damage

055

Opponent Token Is: Chasing - Trick A (Or) Yourself

Opponent Token Is: Evading - Yourself (Or) Yourself

To Use Right Section: if you are 1 spot away from the opponent token and you have a weapon form attached to you.

Opponent Token Is: Chasing - Yourself (Or) Yourself

Opponent Token Is: Evading - Yourself (Or) Yourself

To Use Right Section: If the opponent's life is half of it's original number and you are attached to a weapon form.

The segment badge, you enter the segment that corresponds to the red letter within this if not already in a segment.

A fall badge, each time the number of drop badge lowered on this's page, only there bring your face closer to the playfield a bit.

Nothing Here.

Player Box, once per. Segment, when you come to this, for each number, go to page with number same as number on this box.

A dive badge, all warps on the page of this page do nothing unless told to be used by a drop badge.

A drop badge, imagine the number on this lower then what it is by 1 each sec. when 0, use the warp you are on of the same page.

A warp, if token moves onto this, it goes to page of number listed on this above, there, it moves on spot of ID listed on this below.

Ignore this

The segment badge, you enter the segment that corresponds to the red letter within this if not already in a segment.

A fall badge, each time the number of drop badge lowered on this's page, only there bring your face closer to the playfield a bit.

Nothing Here.

Player Box, once per. Segment, when you come to this, for each number, go to page with number same as number on this box.

A dive badge, all warps on the page of this page do nothing unless told to be used by a drop badge.

A drop badge, imagine the number on this lower then what it is by 1 each sec. when 0, use the warp you are on of the same page.

A warp, if token moves onto this, it goes to page of number listed on this above, there, it moves on spot of ID listed on this below.

Ignore this

Hit 057, Act A, E, C, F, D, 056 Do Damage

Listed Page: 035 Listed ID: C2	Listed Page: 035 Listed ID: C2	Listed Page: 035 Listed ID: A3	Listed Page: 035 Listed ID: A3	Listed Page: 035 Listed ID: A3	Listed Page: 035 Listed ID: A3
Listed Page: 035 Listed ID: C2	Listed Page: 035 Listed ID: C2	Listed Page: 035 Listed ID: C2	Listed Page: 018 Listed ID: D3	Listed Page: 018 Listed ID: D3	Listed Page: 035 Listed ID: C6
Listed Page: 035 Listed ID: C2	Listed Page: 035 Listed ID: C2	Listed Page: 017 Listed ID: C5	Listed Page: 017 Listed ID: C5	Listed Page: 017 Listed ID: C5	Listed Page: 035 Listed ID: C6
Listed Page: 035 Listed ID: C2	Listed Page: 035 Listed ID: C2	Listed Page: 016 Listed ID: C4	Listed Page: 016 Listed ID: C4	Listed Page: 016 Listed ID: C4	Listed Page: 035 Listed ID: C6

Hit 057, Act A, E, C, F, D, 056 Do Damage

Listed Page: 035 Listed ID: A1	Listed Page: 035 Listed ID: A2	Listed Page: 035 Listed ID: A2	Listed Page: 035 Listed ID: A5	Listed Page: 035 Listed ID: A5	Listed Page: 035 Listed ID: A6
Listed Page: 035 Listed ID: A1	Listed Page: 012 Listed ID: C2	Listed Page: 013 Listed ID: C2	Listed Page: 013 Listed ID: C5	Listed Page: 014 Listed ID: B3	Listed Page: 035 Listed ID: A6
Listed Page: 035 Listed ID: D1	Listed Page: 010 Listed ID: C5	Listed Page: 010 Listed ID: D5	Listed Page: 014 Listed ID: D1	Listed Page: 014 Listed ID: D3	Listed Page: 035 Listed ID: D6
Listed Page: 035 Listed ID: D1	Listed Page: 010 Listed ID: C2	Listed Page: 009 Listed ID: D3	Listed Page: 009 Listed ID: C3	Listed Page: 035 Listed ID: D6	Listed Page: 035 Listed ID: D6

Opponent Token Is: Chasing - Yourself (Or) Yourself | Opponent Token Is: Evading - Yourself (Or) Yourself
To Use Right Section: If the opponent's life is half of it's original number and you are attached to a weapon form.

36 You: Page 042 / Opponent: Page 044 | Play Music: 02 (To use go to page 047) | Ignore This.

Opponent Token Is: Chasing - Yourself (Or) Yourself | Opponent Token Is: Evading - Yourself (Or) Yourself
To Use Right Section: If the opponent's life is half of it's original number and you are attached to a weapon form.

37 You: Page 042 / Opponent: Page 044 | Play Music: 02 (To use go to page 047) | Ignore This.



Weapon: A

Greatest

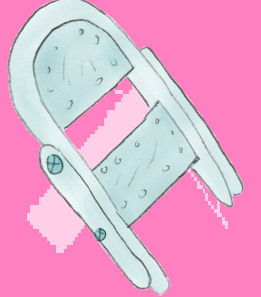

Weapon: B

Greatest

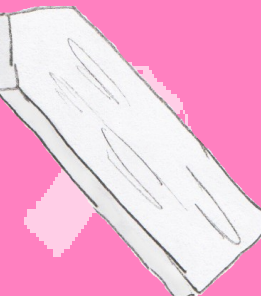

Weapon: C

Greater



Weapon: D

Greater



Weapon: E

Greatest

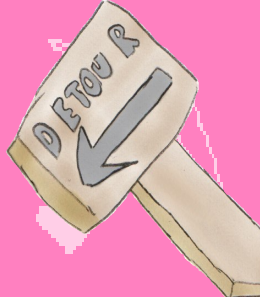

Weapon: F

Greatest



Weapon: G

Greatest



Weapon: H

Greater

The scene page, at entry , follow the arrows in reverse to the first section, and read it, to do that, read all text bubbles/boxes in it. The page title, it means this page is a scene page, in order for this page to be a match the letter in this must also match segment .

A segue arrow, when you read a section of the scene page, follow this into the next section and read it like the last. A game over page box, when you read all sections of this page, the game session ends, you can stop playing now (game end).

A tune box, read/pronounce the red words in this box then hum the rhythm of that pronunciation in your mind reading section. Nothing Here.

Nothing Here.

Panel 1: Didda-Dell Dodo-Diddell, Didda-Dell Dodo-Diddell Diddid, Ditto Diddid Ditto (keep repeating as you are reading this section). "Click, Click" Just do it. Hey! This is not a reward, you tricked me!

Panel 2: Really? What is it? Take me there! You won a reward! Doot Daydit Dydit Deet, Duh-Deet Duh-Deetty (keep repeating as you are reading this section).

Panel 3: I'm working! Well you damaged it, now you fix it. Tiddit-Toot, Tuhtit-Tuhtoot (keep repeating as you are reading this section). I'm working come on!

Panel 4: See you next time! pals! Duh Doo Dut Dut-Didduh Dooow, Dee Deh Dit Deet-Didduh Dooow, Duh Doo Dut, Dut-Didduh Deet.

The scene page, at entry , follow the arrows in reverse to the first section, and read it, to do that, read all text bubbles/boxes in it. The page title, it means this page is a scene page, in order for this page to be a match the letter in this must also match segment .

A segue arrow, when you read a section of the scene page, follow this into the next section and read it like the last. A game over page box, when you read all sections of this page, the game session ends, you can stop playing now (game end).

A tune box, read/pronounce the red words in this box then hum the rhythm of that pronunciation in your mind reading section. Nothing Here.

Nothing Here.

Panel 1: Hoe Heh Hah-Hah, Howhuh Hoe Hoe, Hoeduh-Hoe (keep repeating as you are reading this section). Ho! Ho! Hey, that's a good look for you! Nuts!

Panel 2: Woah! Ah! Ah! Zohet Zohzoh Zeeat, Zohzoh Zuuzet Zohzoh (keep repeating as you are reading this section).

Panel 3: Boo Boo Budda Buh, Pat Pat Peh, Boo Boo Budda Buh, Pay Peh, Boo Boo Budda Buh, Pat Pat Peh, Boo Boo Budda Buh, Pet Puh Puh.

Panel 4: Game Over



The brother of Pually Pinwheel, he springs into action, can jump really high and hop too, he is a useful android to the nuclear industry.

Sammy Slinkee

052 How to Move

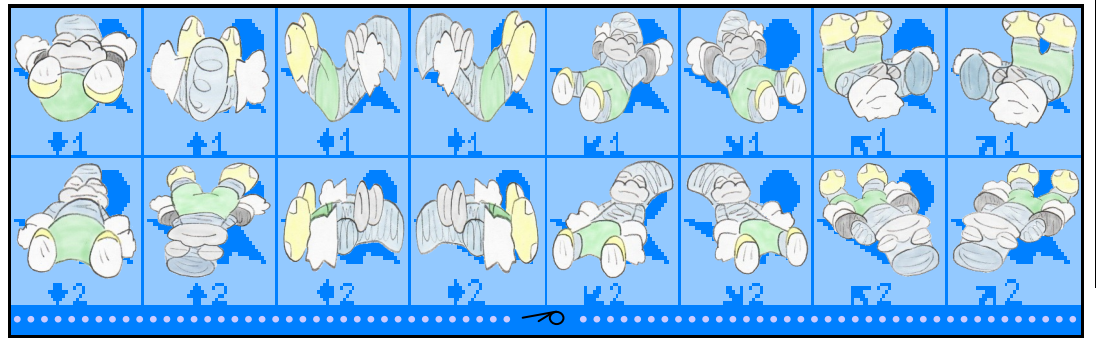
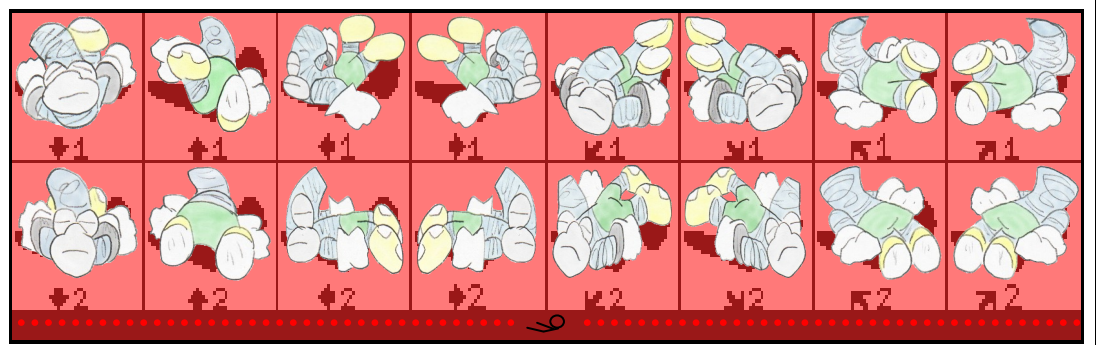
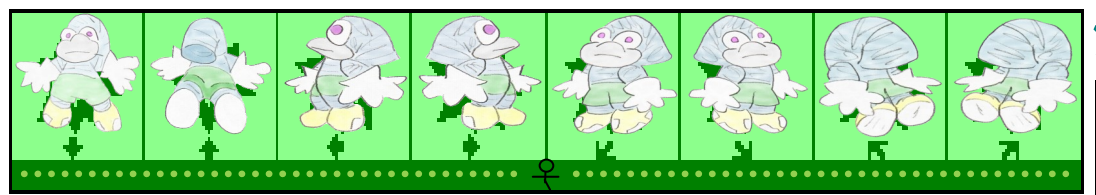
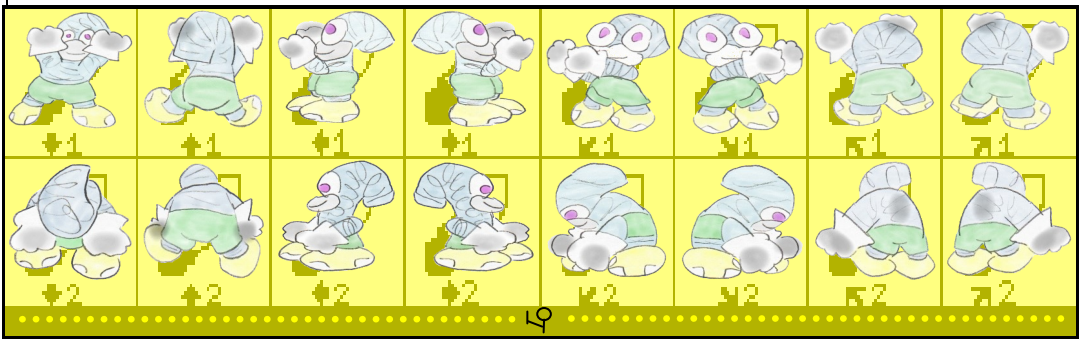

053 How to Display



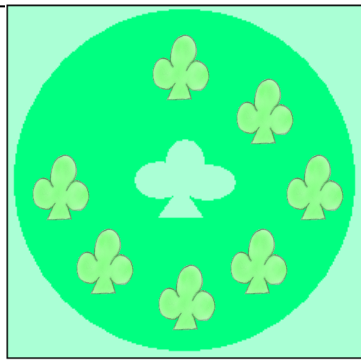

A Rare Cryptid. Persey has a temper, but a gentleman most of the time. One of the senior cryptids and a parent to Trampoline.

Persey Devil

052 How to Move

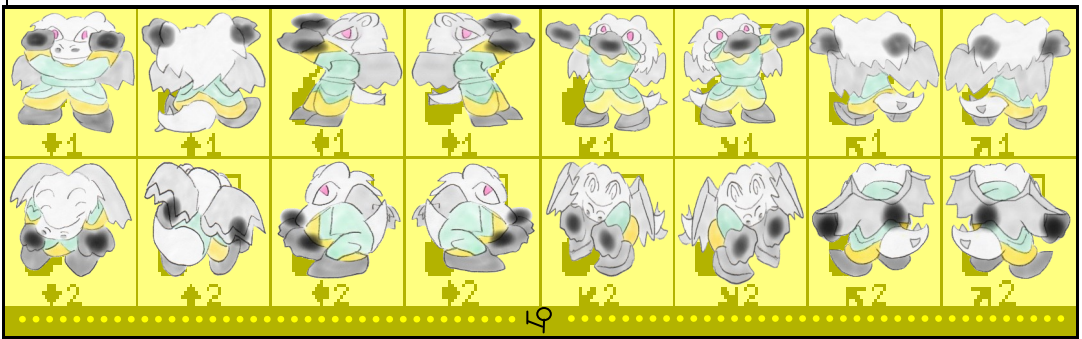
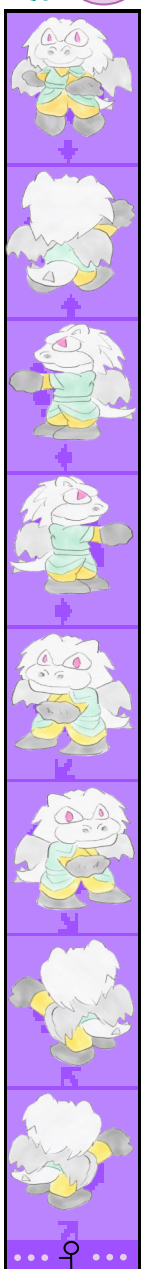

053 How to Display

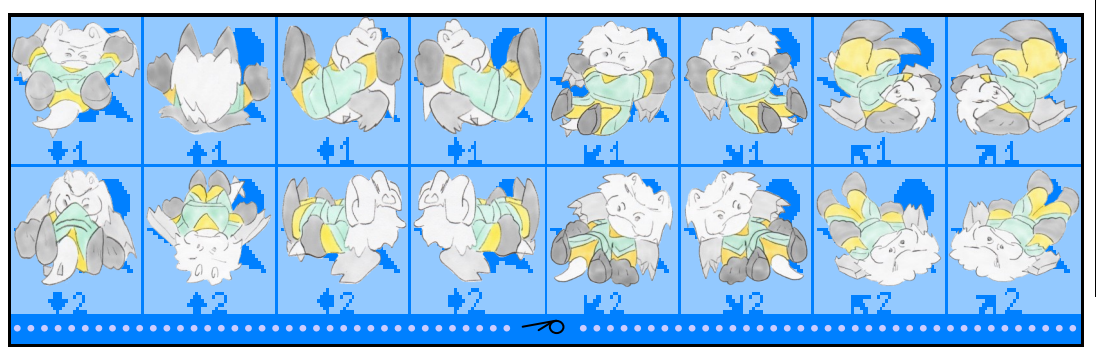
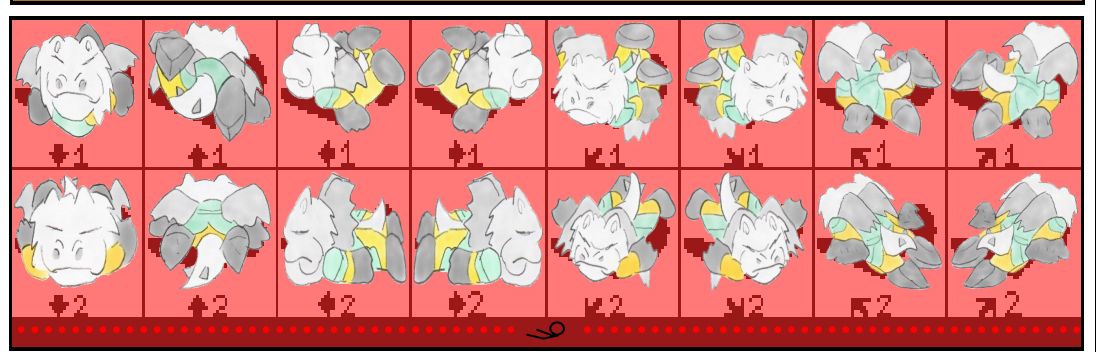

Duh Doo Dut, =Dut +Did Duh =Dow", Dee Deh Dit, Dee +Duh Dit, =Dow", Duh Doo Dut, =Dut +Did Duh =Dow", Dee Deh Dit, Dee +Duh Dit, =Dow", Doe Doe Ditto' +Doo Doo =Daddo, Doe Doe Ditto' +Doo Doo", =Doe Doe Ditto' +Doo Doo =Daddo, Doe Doe Ditto' Duewel"', Huh"' Hoonah Huh Haha Hoo"', How"' Honah How Hoho Hee"', Doe Doe Ditto' +Doo Doo =Daddo, Doe Doe Ditto' +Doo Doo", =Doe Doe Ditto' +Doo Doo =Daddo, Doe Doe Ditto' Duewel"'.

(Once)

This is optional, but to use, read and pronounce the words in the box above in your imagination then hum the rhythm of that pronunciation, the words are colored so that you can read it in pieces and understand the whole song once all the pieces are understood, once understood, classify the play music number on the side of this page to that song, now return to the page that took you to this page, when on a page with a "Play Music" Box.

You can hum the song classified to that number in your mind while on that page, now the word within parentheses at the lower right corner of the box determines if the song is repeatable or not, if it says "Once" after humming the whole song you just stop, if it says "Repeat" after humming the whole song, repeat it again endlessly while on a page of matching play music box (of the same number), if there is a vertical line (|) within a music box, when a repeat occurs, start the repeat after that line, there are Sub-Characters that can change how words are pronounced, check below to see how they work...

The note type character only affects a single word at a time meaning if one word has this character in front of it affects only that word not the next word (S) unless they have their own note type character in front of it, the note type characters are below....

Right Arrow(>): When this character is before a word, you must fade out the sound of the word after this character by lowering its tone softly in till you hear nothing then you go on to the next word.

Left Arrow(<): When this character is before a word, you must fade in the sound of the word after this character by raising its tone from nothing (silence) in till you hear it at its normal tone then you go on to the next word.

Comma(,): When you reach this, you pause for a moment before reading on to next word after this character (the pause is perceived by you as a brief enough the separate two sounds from each other), additional commas extends to pause period.

Apostrophe('): when this character is after a word, you must hang the word's end sound for a moment by extending end's sound, the sound can be hanged longer with additional apostrophes after this one.

The song type character affects the rest of the song after it, meaning if one word has this character in front of it, all words after are now affected by this character when you read over them, the song type characters are below...

Plus(+): All words after this are read vary quickly in till you reach a minus or a equal character, you if you encounter a another plus don't go any faster.

Minus(-): All words after this are read slowly (Make sure it is slower then your normal reading speed) in till you reach a plus or a equal character, if you encounter a another minus don't go any slower.

Upvee (^): All words after this have their sound pronounced in a higher tone then you would pronounce it normally (Make sure it is higher then your normal tone) in till you reach a vee or a equal character, don't go any higher for another Upvee.

Vee (V): All words after this have their sound pronounced in a lower tone then you would pronounce it normally (Make sure it is lower then your normal tone) in till you reach a upvee or a equal character, don't go any lower for another Vee

Equal(=): All words after this are read in your Traditional (Normal) Speed as well as your normal tone, Of course you always start on this speed and read on this tone when reading a music box unless a character at the vary beginning of the music box.

Music Page "Play Music 01"

Duh Ha", Wonga Wuh Ha Won, Duh Ha", Wonga Wuh Ha Won | Wonga Wuh Ha Wonga, Wonga Wuh Ha Won, Wonga Wuh Ha Wonga, Woo Huh, Woo Huh Wee, Wonga Wuh Ha Wonga, Wonga Wuh Ha Won, Wonga Wuh Ha Wonga, Wonga Wuh Ha Wuhwuh Wuhwong, Duh Ha", Wonga Wuh Ha Wong, Duh Ha", Wonga Wuh Ha Wong. (Repeat)

This is optional, but to use, read and pronounce the words in the box above in your imagination then hum the rhythm of that pronunciation, the words are colored so that you can read it in pieces and understand the whole song once all the pieces are understood, once understood, classify the play music number on the side of this page to that song, now return to the page that took you to this page, when on a page with a "Play Music" Box.

You can hum the song classified to that number in your mind while on that page, now the word within parentheses at the lower right corner of the box determines if the song is repeatable or not, if it says "Once" after humming the whole song you just stop, if it says "Repeat" after humming the whole song, repeat it again endlessly while on a page of matching play music box (of the same number), if there is a vertical line (|) within a music box, when a repeat occurs, start the repeat after that line, there are Sub-Characters that can change how words are pronounced, check below to see how they work...

The note type character only affects a single word at a time meaning if one word has this character in front of it affects only that word not the next word (S) unless they have their own note type character in front of it, the note type characters are below....

Right Arrow(>): When this character is before a word, you must fade out the sound of the word after this character by lowering its tone softly in till you hear nothing then you go on to the next word.

Left Arrow(<): When this character is before a word, you must fade in the sound of the word after this character by raising its tone from nothing (silence) in till you hear it at its normal tone then you go on to the next word.

Comma(,): When you reach this, you pause for a moment before reading on to next word after this character (the pause is perceived by you as a brief enough the separate two sounds from each other), additional commas extends to pause period.

Apostrophe('): when this character is after a word, you must hang the word's end sound for a moment by extending end's sound, the sound can be hanged longer with additional apostrophes after this one.

The song type character affects the rest of the song after it, meaning if one word has this character in front of it, all words after are now affected by this character when you read over them, the song type characters are below...

Plus(+): All words after this are read vary quickly in till you reach a minus or a equal character, you if you encounter a another plus don't go any faster.

Minus(-): All words after this are read slowly (Make sure it is slower then your normal reading speed) in till you reach a plus or a equal character, if you encounter a another minus don't go any slower.

Upvee (^): All words after this have their sound pronounced in a higher tone then you would pronounce it normally (Make sure it is higher then your normal tone) in till you reach a vee or a equal character, don't go any higher for another Upvee.

Vee (V): All words after this have their sound pronounced in a lower tone then you would pronounce it normally (Make sure it is lower then your normal tone) in till you reach a upvee or a equal character, don't go any lower for another Vee

Equal(=): All words after this are read in your Traditional (Normal) Speed as well as your normal tone, Of course you always start on this speed and read on this tone when reading a music box unless a character at the vary beginning of the music box.

Music Page "Play Music 02"

Gamebook Start Guide

Welcome, Friend! To play this type of gamebook, you need to learn how rules are taught in this type of gamebook, rules are taught through objects which is called a “Note”, a note is a blue ring with a small blue colored phrase wrapped around it, and a black letter or number in its center, see example below...



A example of a note, see the object on the left.

So how it works is, When you do something that matches the blue phrase wrapped around a note, and you did that action to a element of the game that is near or contacting that note (or a element with no note but looks the same or close like the one that matching note is contacting/close to), that note is acted.

The blue phrase around a note is read clockwise, also a letter or number within parentheses that is in a blue phrase of a note pertains to another note with that letter or number in that note’s ring. Now when you act a note or a note is acted, on the acted note will be a black letter or number within the center of the ring that makes up that note, if it is a letter.

Compare that letter to one of the letters underlaid in the tutorial box on the same page (except G, which is at the beginning, not underlaid) as that note, but what is a tutorial box? See below...

A example showing that a explanation of a feature needed or used will be displayed here for you to learn at that moment.	A example showing that a explanation of a feature needed or used will be displayed here for you to learn at that moment.	A example showing that a explanation of a feature needed or used will be displayed here for you to learn at that moment.
A example showing that a explanation of a feature needed or used will be displayed here for you to learn at that moment.	A example showing that a explanation of a feature needed or used will be displayed here for you to learn at that moment.	A example showing that a explanation of a feature needed or used will be displayed here for you to learn at that moment.
A example showing that a explanation of a feature needed or used will be displayed here for you to learn at that moment.	A example showing that a explanation of a feature needed or used will be displayed here for you to learn at that moment.	A example showing that a explanation of a feature needed or used will be displayed here for you to learn at that moment.

So, on the section of the letter underlaid or in front (the whole dotted box around that letter) matching the letter of the acted note, read everything in that section to understand the element. Now, if it is a number within the center of the ring that makes up that acted note.

Go to the page with a page number that matches that black number and read everything in that page to understand the element, after its read, you are returned to the page and position before being taken to that page. It is recommended to pause your game session and test the newly learned feature as soon as it is learned by you so you can get used to it then continue your gameplay session after, as soon as a element is known, it can take effect immediately if it take effect at/before knowing it.

Now if you come to a page and need to understand something, You can choose to act a note anytime (regardless of situation) in order to resolve this misunderstanding. Also, you can choose to ignore any notes that teach features or elements of the game that you already know of unless they are “Red” colored notes as those hint at features which contain slight changes and must be read when they are acted (every once per entry of page). You are done, please go back to the page that take you here.



Bookmark Key: EE Kindergarten Khaos

Like any other book, you use bookmarks to remember where you last left off in a book, but in gamebooks, it is a bit different, to learn how to bookmark in this game, use the instruction under this. You have to use the bookmark key above (sentence in red) to use a bookmark, to create a bookmark, and to edit a bookmark for this game, take this bookmark key above to do either of those.

Bookmarking

You will learn how to bookmark for this game, it is the same as normal bookmarking, but you need to also write down what you did in this game on the bookmark itself, so first upon your bookmark’s creation, write the taken bookmark key from this game on the top part of the bookmark then cut it off from the rest of the bookmark with a dotted line.

Now write small notes about everything you did during your play session at the time you are “book marking” on the rest of the bookmark as well as its backside, the side with the written bookmark key is the front side, it is recommend that the notes are phrases which are around 3 words long so you can fit as much as you can.

When you want to change or read a currently existing bookmark, first compare bookmark keys by comparing the taken bookmark key with the one written on top of the bookmark of its front side, if it is a match, that book mark can be used for changing or reading, if not, then attempt to use another or do not use a bookmark.

When you want to change a currently existing bookmark, after checking that it can be used, just erase notes that do not match your situation at the time of “Bookmarking” and add notes that do not already exist on that bookmark that match your situation at the time of “Bookmarking”.

When you want to read from a currently existing bookmark and continue where you last left off, after checking that it can be used, just remember what your notes meant and form your situation from all the notes you wrote on both the front and back sides of that bookmark

Remember to go to the actor pages of the tokens paired to character to have them re-become to their character, also, go around pages and apply more pictures from squares to tokens that were applied to additional forms outside their actor pages, this should be considered when writing down the notes (like page number references). Please return back to the page (and position) that take you here when done with this page.



The gray square with a letter and number on the lower left corner of it is called a "Spot", and the letter and number on the lower left corner of that spot is that spot's ID, there is also a section on the lower right corner used for "Stamps" called the stamp section, which you will learn a little later.

Spots are the main way you interact with this game, and this is done by you, yourself, existing on spots, but how do you exist on a spot? Well you command a "Token" around as if it were yourself, and this token is called the "Token You Control" or "Your Token", that token is you in this game, yourself (you) in this game refers to the token you control (your token), and where it is taken you are taken with it.

But what is a token? A token is a imaginary object that you envision on the spot that it is on, basically it is not actually there, but you project the imaginary image onto the spot it is on using your imagination as a imaginary apparition, on the actual page itself, in cases that you imagine something already on the page as something different then what it really is, that change itself is considered a token because it is a imagined.

The difference is, it is considered a part of the element that the change take place and applied to where it take place, if a change (as a token) is taken to another page, it is applied to the element that matches (or matches most) the element it was taken from and applied in the same place.

When you leave a page normally, all tokens are removed from that page upon your departure (except any tokens taken to the same page your going to, as is), your token is taken with you to the spot on that new page, with that being known, for now you can imagine your token as a ball or circle for now where it was placed.

Now, if there is another spot right next to the spot a token is on (where they are sharing a line/wall), that token can move onto that spot, however, it can only do this once per second that you think have passed, the multiple spots all connected to each other as a grid on a page is known as the "Playfield" for that page. Now if there is a element that a token is allowed to move into/onto that is in a "Illegal zone" (which means it is not within a spot or on a spot that token cannot move onto), and it is right next to the spot that token is on in either case.

That token is allowed to do so, however, that action is not done, instead consider it moving onto that element. Now, as explained before the stamp section is used for stamps, a stamp is a special element that resides on a spot, and each one has it's own effect on the game and moving onto a spot that has a stamp on it, means to move onto that stamp itself, you will learn your first 2 stamps now.

The 1st is the restrict stamp, all it is a star (✱), what the restrict stamp does is, whatever (other than a "Token") is sharing a spot with this can only be used (by any "Token") once per entry of it's playfield, if a attempt to break this rule occurs, that element does nothing. Last is the solid stamp, all it is, is a circle (●), what it does is. No token can move onto the spot of this stamp, including you, the token you control.

A page pair with a page that contains a Actor Box is called together a "Actor Page", but what is a actor box? See below...

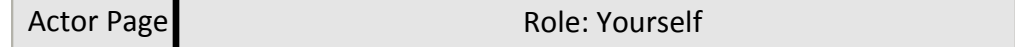

So the words "Actor Page" on the left declare that box is a actor box, now, depending on the role after the black line on that box, will determine how that actor page (the one with that actor box) is used and what token is affected, once that is sorted out, normally you start the affected token's transformation after.



At the start of the affected token's transformation, a number is created and attached to that token called the "Life" so set this number by counting all the clubs in the club box (like the example on the left) of that actor page and the number you got from counting those becomes that "Life" number (Ignore the club pattern in the middle).

So on the rest of that actor page (pair) you will see many boxes containing squares with pictures, you use these boxes to create "Forms" for the token being transformed, to create a "form", study (Stare and memorize) all the pictures (or animations) in all squares of one of these "picture boxes" and input those pictures into your imagination (you can paraphrase those memories if easier), group those pictures from that box together into a group called a "Form"

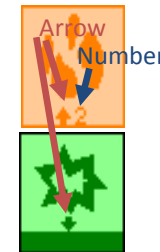

At the time of imputing each picture, classify it's purpose using the arrow and number (if there) under that picture (for each square), these pictures are purposed as the appearance for the token being transformed, so the arrow classifies that picture as it will only be used when that token is in the direction of what that arrow is pointing to.

And the number classifies that picture as one of the pictures in the order for that direction (if there is more then one picture (square) to that direction in that box).

Now, finish up that form, by labeling that form as the "Stick Figure" image listed at the bottom of the box that the form's pictures was group in from (that figure gives a visual hint of what the form is suppose to show, this completes that form's creation, now, associate that form with that image then pair that form with the token that is being transformed.



Finally, once forms are created from each box on that actor page, remember that association/relation between that token and those forms, that token's transformation is then done, you then leave that actor page back to the page before you were sent to that actor page and that token is envisioned/starts in down direction.

So when a actor page box contains a role that says "Yourself", that page is for you, your token (the token you control) is the affected token for that actor page (you will learn later about your token if not known).

With a understanding how tokens are transformed, the real way you envision a token is as it's transformed state, that is to use it's paired forms projected on the playfield and that projection is the token itself, you will be thought how to do just this now.

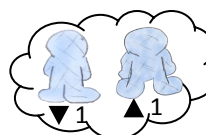
 So you envision the transformed token as the picture that is classified as the direction the token is in and order number pertaining to the action that the token is doing at the time, you envision the picture of the token as large as the spot (square) the token is occupying at the time, when a token is placed on a spot it starts in down direction.

 If you forget some or all of the pictures that make up a form, you can return to the page where you got the pictures for that form and refresh the memories from there when needed. A token's appearance changes when it moves, this gives life to the token as if it is that character moving through that environment.



So, every token uses the (☞) form that is paired to that token as it's original (main) appearance, this means you use the pictures from the form paired to that token that is labeled as that stick figure, when told to change the main appearance of a token, start using the pictures from the form paired to that token that is labeled as the stick figure told, continuing on, this is how a token exist and moves transformed, see below...

 Envision the token as the picture 1 of that direction (or the single picture of that direction) it is in of it's form currently being used as the main appearance if the token is not moving (or stopped).
 When the token moves 1 spot from not moving or changing directions, and that direction has more than 1 picture in it's order, first you envision the token as picture 2 of the direction it is moving in of that same form, then imagine the picture (token itself) sliding into the next spot after to complete the change.
 If that direction has more than 2 pictures, when the token moves 1 spot in the same direction it is in from the last spot as picture 2, you first envision the token as picture 3 of that same direction and form, then imagine it sliding into the next spot after, when the token moves 1 spot in the same direction it is in from the last spot as picture 3, repeat this step except envision the token as picture 2.

There are special numbers in this game called a "Incise", a incise is just a gold number, which all gold numbers are given this title, when a incise is performed, unless 0, move the affected token that many number of spots equal to what that "Incise" is (as a number) in the direction the affected token is in.

Now with you fully understanding how a token is envisioned, a token can have it's appearance briefly changed without actually moving or doing action, this is called a display, so when told to use a stick figure form for a period of time.

It means to change the transformed token to the appearance of pictures in a form paired to it that has a label matching that stick figure for that duration of time, continue below...

 1 So you will be told a duration (time amount) to use that form as, and depending on how many pictures exist for that direction, divide that duration (in seconds, or half, or threes of a second) into parts equal to the number of pictures that exist of that direction.
 2 Envision the paired token as all pictures one by one each for each divided duration part, starting at picture 1 of the direction that the token is in and going up by 1 in that direction order until you reach the highest number of the order.
 3 If a single picture only exist for that direction, then always envision the token as that picture of that direction for the total duration, once the time duration is up, the token is return to it's original appearance (form).

When told to use a form as a display, it means to use this process you learned above. A small way displays are used is by the "Stick Figure", yes the same stick figures for forms, but when outside of a actor page they serve a different function, this has two functions, first if a stick figure is performed or used and you are told to use/perform it for a set period of time.

Then the affected token uses it's form of that stick figure (image) as a display for that time period. The 2nd function is not related to this explanation, but good to mention, when the stick figure is performed or used with a another feature that moves a token (like a incise).

Change the main appearance of the affected token to it's form that corresponds to that stick figure (image) until that movement (direction change included) is done then it is returned to it's original appearance.

Moving tokens to a different page "as is" means to take all tokens from their areas of the page and place them on the new page in the same areas as the page those tokens were taken from, changes (as tokens) from "red numbers" are not moved, rather they are automatically removed, With that being known, you now know "Form" for other notes.

This page is for a explanation of a feature or element called a "Opponent Token".

This on the left is a opponent badge, if present, create a token and call it the "Opponent Token", have the opponent token be imagined as a square or box for now (smaller than it's spot), now you and a opponent go at it, that is fighting and playing tricks on each other, but what is a "Opponent"? well it is a token trying to make you lose the game, so when a actor page box contains a role that says "Opponent".

That page is for the opponent, the opponent token is the affected token for that actor page. it is placed on a spot next to your token of your choosing of the playfield you first come to after it's transformation, it then starts in down direction. The opponent token's movement is based around it's "Target", that is if the opponent token is chasing it's target or evading it's target.

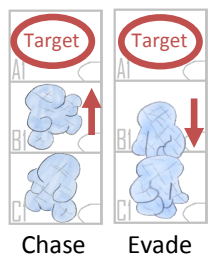

So the opponent token always moves repeatedly 1 spot, but the direction in which it moves in is dependent on if it is chasing or evading, if the token is "Chasing" it's target, it will move in the (most possible) direction of it's target from itself. If the opponent token is "Evading" it's target, it will move in the opposite (most possible) direction of it's target from itself. (the target of the opponent token will be explained when appropriate or when the time is ready).

If the opponent token leaves the page to another, it cannot leave your perspective, so consider it going to the page and spot it was supposed to go to in it's leave attempt in your imagination and remove the opponent token from that page.

When you enter a page where the opponent token is considered to be at, it is placed from your imaginary consideration onto a real spot of that page with a ID that matches the ID of the spot it is considered to be on, it is then no longer imaginarily considered as it is on a real spot of that page.

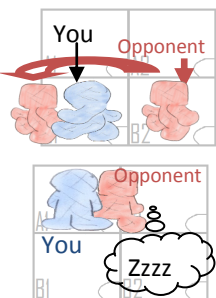
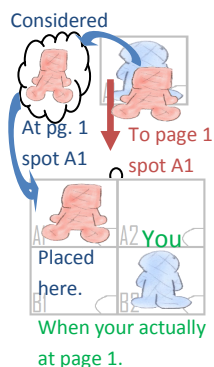

If you leave the page to another one, before your departure, if the opponent token is not already considered in another page, then the opponent token tails you by going to that page and spot you were going in before you go there.

if you (your token) and a opponent token are sharing the same spot, the opponent token "Rests" until both are not sharing that spot, when the opponent token rests, both you and the opponent token do nothing to each other and the opponent token does not move. If you want to save mental energy, and both you and the opponent token move at the same time, you can envision your movement first then the opponent's after 1 by 1. You now know "Foe" for other notes.

This page is for a explanation of a feature or element called the "Opponent Box".

A opponent box is green and orange colored box that has 3 sections that are separated by a dotted line (excluding the color circle on the left), 2 above, and a single large one below, see below...

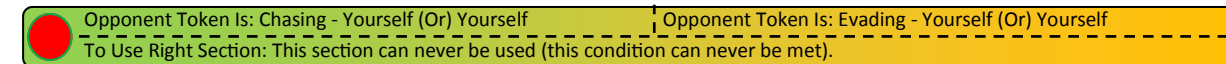

The opponent box is basically the opponent token's choices, now, when the opponent token is present on the same page as this box, you must use one of the 2 sections above in that box. This choice is determined by the lower larger section of the box, which states a situation, if your situation matches the situation in the bottom larger section, you use the right above section as it implies, If not, use the left above section.

So on the used section, after the phrase "Opponent Token Is" is one of the movement actions that the opponent does with it's target, and after that is a dash and two "Labels" separated by the word "Or" within parentheses, the label before that word "Or" is the target for the opponent token, unless that label is "Unfavorable" then the label after that word "Or" is the target for the opponent token.

If both labels are "Unfavorable" to the opponent token, then you, the token you control becomes the target for the opponent token, for convenience, there is a colored circle on the left of every opponent box, which is there to alert to informational changes on a opponent box to let you know when to read the opponent box when it changes (just for that segment), so you do not need to reread the same information on each box. If you and the opponent token share a spot and you do not move first, the opponent token moves onto a spot next to your token that it can move to (of your choice).

When the opponent token is on a spot next to the token you control, if it tailed you, once per tail, it does nothing for 1 second, now, if it did not tail you or it used up that 1 second, the opponent token automatically chooses the spot you are on to attack (you will learn when it is time), now a "Label" in a opponent box is any feature/element of the game including your token, a unfavorable label is a feature that is not present on that playfield, cannot be used by the opponent token (including if it cannot be moved on), or does nothing for the opponent token, the label list for features of the game are below...

"Yourself": this is a label for you, the token your control.

"Weapon": A letter is also included with this label, it is a label for a feature of the game that can equip a Letter that corresponds to the letter within (after) this label.

"Trick": A letter is also included with this label, it is a label for a feature of the game that can play a trick of the same letter as the letter within (after) this label.

"Link": it is a label for a feature of the game that is closest to the opponent token when it is in a spot at the time, that can move the opponent object to a different page.

"Solid": it is a label for a feature of the game that is closest to the opponent token when it is in a spot at the time, that cannot be moved onto by the opponent object.

"Fall": it is a label for a feature of the game that is closest to the opponent token when it is in a spot at the time, that can force the opponent object to move not of it's own choice (by the opponent box).

The aftermath of a action is doing damage, so when told to do damage to a token (or damage is done on a token), reduce the "Life" attached to the token having damage done by the amount equal to the damage being done.

When the "Life" of the token you control becomes 0 you lose, when you lose, look amongst the pages for a "Lose Scene Page" (look at the bottom left of each page) with a letter in quotes that matches the letter of the current segment you are in and go to that page.

If the "Life" of the Opponent Token becomes 0, then you win, when you win, same thing as if you lose but you look for a "Win Scene Page" instead of a lose scene page.

Now when you are told to end the game session, remove everything in your imagination related to that session, you are no longer in that segment you were in at the time you were told end the game session, your token is untransformed.

(your token cannot be removed as it always exist as yourself). You now understand the basic gameflow, which means, you now know "Flow" for other notes.



The main thing tokens do is fight, so a token (including you, the token you control) can choose any spot to attack (to resolve problems, the token that moved next to the other first gets first choice), anything in that spot count as it getting attacked.

Each token has a power style which starts at "Lesser" this is the original style or default for each token, now, if a token is attacked, the token that choose the attack is the "User" and the token getting attacked is the "Target".

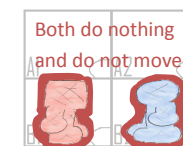

Start period, a period is a phase where both the user and target tokens are locked in place, when a period is started, unless specified, all tokens are changed to down direction, during a period, all tokens do nothing (including movement) and are unaffected by anything not performed until the period ends, when the period ends if any token where moved during that period, move them back to their spot and direction they when in when the period started.

Also when a period ends all tokens looks are changed back to normal meaning they use their original appearance form, if tokens were labeled as "User" or "Target" those tokens are no longer labeled as those labels when a period ends.

Back to the attack, both tokens remain in there direction they in before the period started instead of changing to down direction, now, the user changes it's look to look like it is hitting by using that token's (♀) form for 1 second in the direction of the chosen spot from that token.

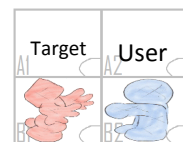
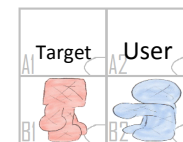

After the user's display (once it's time is up as it's changed look), the target then changes it's look to look like it's being hit, so depending on the user's power style, if it is "Lesser", use the target token's (♀) form for 1 second, if "Greater", use the target token's (⊗) form for 1 second, and if "Greatest", use the target token's (⊖) form for 3 seconds.

Additionally if "Greatest" and there is a spot you can move onto past the target in the direction of the target from the user, have the target token slide into that spot during the target token's display (during it's time is up as it's changed look) sliding as picture by picture during spot transition in numeral order, keep the direction of it as it is sliding like this.

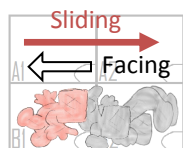

After that display of the target token, the target token then changes it's look to look like it's being knocked to the floor, so once again, depending on the user's power style if it is "Lesser" or "Greater", use the target token's (♫) form for 2 seconds, or if just "Greatest", use the target token's (↪) form for 2 seconds.

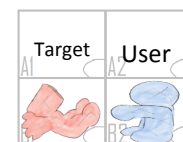

Once that display of the target token is done (once it's time is up as it's changed look), do damage to the target token depending on the user's power style, "Lesser" does 1 damage, "Greater" does 2 damage, and "Greatest" does 3 damage. Once that damage has been done, then the period ends, and wait (any choosing of a spot to attack at the time that attack is done does nothing until 1 second you has passed is waiting).

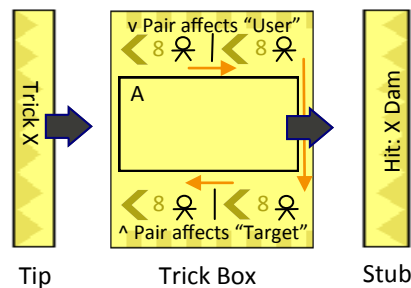



The trick strip is made up first of a "Tip", one or multiple "Trick Box (es)", and a "Stub", see left for these elements. Now, when a "Trick" matching the trick on the "Tip" (see left) is played, start the period, then play whatever the black arrow of that tip is pointing into.

Now when a "Trick Box" (see left) is played, perform every thing in the 4 sections around this's box, as you can see the sections are in pairs of two that are separated by a line, each section is made up of a "Engraving" a special character that is golden, a "Incise", and "Stick Figure".

When all those 3 characters are performed by their own rules in that section, you are done with a section, follow the orange arrow to the next section, as explained on the trick box, the affected token for the two top sections is the "User" and the affected token for the two bottom sections is the "Target", when done with all sections then play whatever the black arrow of that trick is pointing into (not the arrow pointing into that box).

When a "Stub" (see up) is played, do damage to the target equal to the number between "Hit" and "Dam" end period after, if there is the phrase "Ride Pet" instead, end period, and go the to page after that phrase and come back when done. The "Engraving" has many effects on the affected token, the list is below...

 **Directional Arrow/Circle:** Means direction change - when performed, if arrow, change the current direction of the affected token to the direction that the arrow is pointing to, if circle, 1 moment by 1 moment, each moment change the direction affected token in a order going clockwise starting from the direction it is in, until it's in it's original direction before this was effect was used. Unless the incise is 0, both the arrow or circle are performed before any incises or stick figures are performed if they were being performed with those.

 **Oval:** Means to shift between visibility - when performed, before any incises and/or stick figures with this are performed, if the affected token has a appearance and is currently being envisioned using a form, the affected token now has no appearance, do not envision any appearance for this token (it's there still), it is returned to it's original form and back to being envisioned when the period ends (you will learn later), if the affected token does not have a appearance and is currently not being envisioned as anything, it is returned to it's original form and back to being envisioned as it's main appearance (original appearance form).

 **Directional Triangle:** Means token placement - when performed, this does nothing, but when performed with a incise, any incises being performed with this do nothing, instead find a spot that is a number of spots away from the affected token's current position equal to the number that is the incise being performed with this, in the direction that the triangle's apex (top) is pointing to, and move the affected token onto that spot.

 **Saw Blade:** Means a action display - when performed, any incises or stick figures being performed with this do nothing, instead use the affected token's stick figure form that corresponds to the stick figure that is being performed with this for a number of seconds equal to the number of pictures that group has for a single direction as a display, in the direction the affected token is currently in.

 **Cross:** Means to skip performance - When performed, it is performed over the other incise and stick figure, treat as if this, and/or the incise and/or stick figure being performed with this as if they are all performed immediately (skip).

 This on the left is a duo badge, if this badge is present and you (your token) is already transformed and a attempt for your token to transform to different character is made, You do not transform to that character.

Instead you combine your current transformation with the attempted one by altering all forms of your current token your control to mix in the pictures in all the squares in that actor page into the forms they would go in.

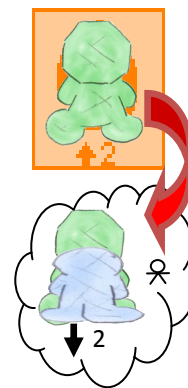

This is done by using the form creation process for each box on that actor page but in this case you do not group them in a new group, instead classify the picture first then mix in that picture onto another picture classified the same as it but in the form of your token that is labeled with the same label as the form that the picture being mixed in would have been grouped in normally.

In the mixing process, the picture that is getting mixed in from the actor page is the following picture, and original picture from that actor is the leading picture, so the mixing process works by simply attaching (or fusing) the following picture onto the leading picture and declaring that fusion a single picture belonging to that form instead of the leading.

Depending on what the direction both the leading and following picture are classified as, if it is a direction for the token facing towards you (your actual face), such as down, southwest, southeast, left, or right, attach the following picture under the leading picture.

When determining sizes for this kind of fusion, the following picture is the size of the box, and the leading picture is three thirds that height (or enough to see the face of the character of the following picture).

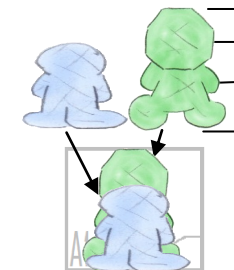

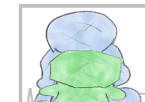
 If the token is facing away from you (your actual face), such as Up, Northwest, or Northeast, attach the following picture over the leading picture, the size for this kind of fusion is vice versa.

Now, all darken spots on any following pictures are treated as if they are not there, this means you also ignore them and they cannot be used.

This on the left is a pet badge, if this badge is present and whatever token (by it's  actions) brought you to this page is already transformed, do not transform to that token if it was supposed to be transformed.

Instead you are to make it, so that token is riding that character of that actor page, this is done by creating a form from just the box that contains the (☞) stick figure on the actor page of this badge (the rest of the other boxes are ignored), and calling that form "Pet", that pet form is then paired and attached to the token that toke you to the page of this badge.

Now, this is where things get tricky, that pet form you just created is not finished yet, to finish it, take each picture classified as picture 1 for each direction (arrow) from the (☞) form of attached/paired token, then copy those pictures and fused them into the newly created pet form of that same token to finish that pet form.



This is done by fusing each copied picture to the set of pictures in that pet form with the direction that matches that copied picture's classification (the copied picture is duplicated for each picture of that direction set), use your own creativity to make it work, to make it seem as if the character is riding the ridden character, this fusion finishes that pet form.

Once a pet form is created for that token that toke you to the page of this badge, you are done, return to the page that toke you to that actor page, so while a token is attached/paired to a pet form, it uses that form for it's main appearance in place of it's (☞) form, If damage is done to make the "Life" of a token that is paired or attached to a pet form 0.

Remove that pet form and that damage is not done, when a pet form is removed, that token then goes back to using it's original appearance afterward. You, yourself can remove a pet if it is equipped to the token you control at any time on a playfield, also a pet form is removed upon pairing/attaching a different pet form to that same token.

Damage done by a token that is paired or attached to a pet form is double the amount that it was supposed to do.

When a token is equipped to a letter and you are directed to a page with nothing but "Weapon Boxes", you need to choose a weapon box based on that letter, but what is a weapon box? See below (towards the left)..



Pick the weapon box with the letter after the word "Weapon" that matches that equipped letter, pair that box to the token of the equipped latter and then removed that equipped later afterward.

On that box, below the "Weapon" word and letter, is a small red word, change the power style of the paired token to that word, after that, there is 8 small squares with pictures in them on the left of that word "Weapon" and letter of that box, use the form creation process learned from actor pages to create a form from those 8 squares and label that form as "Weapon", attach that form to the paired token.

If there was already a weapon form attached to that token that is different from the one being created, then remove other weapon form first, remember that relation between that token and that form, once done with that, un-pair the token with that box then return to the page that toke you to that weapon box page.

When a token attached to a weapon form chooses to attack (choosing a spot to attack) and a token is attacked as result, when the user changes it's look to look like it is hitting, it uses that (user) token's (☞) form for 2 seconds in the direction of the target instead of it's usual (☞) form, and not only that, but during that display, you imagine that token's character holding the weapon.

So depending on what the direction the token is facing If the token is facing towards you (your actual face), such as Down, Southwest, Southeast, Left, or Right, or if the token is facing away from you (your actual face), such as Up, Northwest, or Northeast.

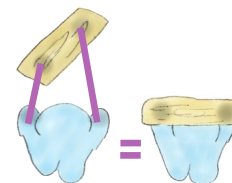

If the token is facing towards you, lay the memorized picture of the attached weapon form that is the same direction as the token, onto the picture of that token, both the pictures of the token and the equipped weapon have darken spots on them, you match up those darken spots in any fashion you want.

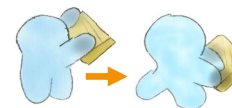

As long both darken spots of the weapon picture meet those of the token, you can rotate and resize the weapon picture so they both meet, when the token's picture changes of the same direction, move weapon picture to have it's darken spots meet the new picture of the token.



If the token is facing away from you, same thing, but lay the picture, under the picture of that token, instead.

This on the left is a jump badge, if this badge is present on an actor page near the name of the character of that actor page, whatever token brought transformed by the actor page with this badge present, is allowed to "Jump".

When you (your token), are allowed to jump, you (your token) can choose to jump anytime on a page where you can move, when a token chooses to jump, consider that token jumping for 2 seconds you think have passed.

During the time a token is considered jumping, use that token that is considered jumping's (♀) form for the time it is considered jumping, also a token cannot choose to jump again during the time it is being considered jumping.

Also when a token is considered jumping, anything that shares a spot with a token considered jumping (other than another token considered jumping) is treated as if that token considered jumping does not share a spot with that element (or did not move onto that spot of that element).

At the moment a token stops being considered jumping, any elements that take effect when a that token moves onto the spot it is on, takes effect immediately at the moment that token stops being considered (a token cannot choose to jump at this time until that element is done taking effect).

If a token can choose to jump during its transition to a different spot, consider that token jumping but do not count the time during that transition towards the time it is supposed to be considered jumping.

When the opponent token is allowed to jump, the opponent token automatically chooses to jump during the transition to a spot with an element that would break the chase of its target, meaning an element that it cannot move onto, an element that takes it to a different page, or an element that would move it in a direction other than the direction it is going in, all that would impede it from reaching its target.

This page is blank on purpose.

Mutireader

If you found this page, yes this game can be played with multiple players, but you can only do so (reading and using what is understood here) when you have played and completed your first play-through of this game, once you did that, continue, when you want to play with other players, there are some guidelines and differences you must follow in order to do so.

First off the page with the Title picture, The Segment Entry, The Segment Plan is ignored, also all scene pages with everything on it are ignored to, all players look through the actor pages of this game and select an actor page of their choosing, each player then treats the role of their selected actor page as if it said "Yourself", (ignore any badges on that actor box).

Once each player's token (the token you control from that player's perspective) is transformed, the players then seek out "Starts" and decide amongst those chosen starts, once a start is chosen each player can move onto any spot that is not already occupied by another player that is on the page of that start of the page of the player who chose that start.

Once this is done, all players enter "Mutireader Style", when you are in mutireader style, the opponent box does nothing, also you do not enter any segments and you cannot enter any segments while in this style, the player box is also ignored and does nothing when in mutireader style, when in mutireader style, every time you move to a different page.

You must say out loud to the other players the page number of the page you just moved to, if a player responds that you move to a page with a page number that is the same as the one that player last said out loud, go to that player and place your token onto that player's page on the spot you moved.

When you leave a page that is another player's, if the page you left to was the same as another player's then repeat and go to that player, if the page you left to is not currently said by any other players, use your own page that corresponds to the page number you went to, now, in mutireader style, you place your finger where your token is, your finger is your token.

But you also still envision that finger as the transformed token, also in mutireader style, you cannot select a box with a player's token to attack, instead you must pounce on that token, to pounce on another player's token, first you must be on a spot right next to that token, then with the finger that is your token you must actually try to tap the finger that is that player's token.

If that token moves away to a different spot or page fast enough, you are then moved onto that spot where that token was, if a player tries to pounce on your token, you can ditch that pounce, to ditch a pounce, at or during the time (maybe slightly at the beginning) of a pounce you can.

As fast as you can move your finger (your token) onto a spot or into a feature that can move you to a different page right next to the spot you are on at the time you do a ditch to make the player doing the pounce miss, you can repeat this as many times as you want to keep yourself safe.

If you happen to tap a player's token even while that token is doing a ditch, if the token you pounced on was doing a ditch, that token goes back to the spot before that ditch was made, regardless after the tap, move your token (finger) back on the spot where the pounce was made.

And go through the attack process where you chose the spot of that tapped token to attack, with your token being the user and that tapped token being the target (skip the wait), if you move onto a "Trick" while in mutireader style, it does nothing unless if there is at least 1 other player token on the same page as your token when using it.

If that is such a case, as long as you are on that trick, use a finger from your other hand (opposite to the one of your token) to try to pounce on a player token on that page from above that page itself (ignore being on the spot right next to that token for this kind of pounce).

If you miss that token with this kind of pounce return to above the page and you can try again, you are still free to move your token while trying to pounce like this, if you tap a player's token from a pounce of a trick, move that tapped token to where your token is at.

Then, play the trick listed on that trick, with your token being the "User" and that tapped token being the "Target". If both tokens share a spot, both tokens do nothing to each other until they move 1 spot away from each other.

Whenever a player gets a new form attached or paired to their token, that player must tell what kind of form it is as well as the actor page of that form and show off it, if a player changes his/her power style, that player must tell the other players of it.

When a player's "Life" becomes 0, that player is eliminated from that gameplay session and cannot partake in it anymore, when only one player remains that is not eliminated, that player is the winner and the that gameplay session ends.